



**SIGMADRIVE AC TRACTION**  
**TECHNICAL MANUAL**  
**SK79646-01**

© PG Drives Technology 2008

All rights reserved.

This manual is furnished under copyright and may only be used in accordance with the terms laid out by PG Drives Technology.

The information in this manual is furnished for informational use only, is subject to change without notice, and should not be construed as a commitment by PG Drives Technology.

Except as permitted by such terms, no part of this manual may be reproduced, stored in a retrieval system, or transmitted, in any form or by any means electronic, mechanical, recording, or otherwise - without the prior written permission of PG Drives Technology. +44 (0) 1425 27144.

## TABLE OF CONTENTS

About this manual.....	6	Pin 6 – Speed Limit 2 / Inch Reverse .....	20
Icons .....	6	Pin 7 – Speed Limit 3 / Handbrake.....	20
<b>Chapter 1 – Installation.....</b>	<b>7</b>	Pin 8 – Accelerator / Footbrake .....	20
<b>1 Introduction.....</b>	<b>9</b>	Pin 9 – Accelerator / Footbrake .....	20
<b>2 Guidelines For Working On Electric Vehicles .</b>	<b>9</b>	Pin 10 – Keyswitch.....	21
2.1 Precautions For Working On Electric Vehicles .....	9	Pin 11 – Contactor Coil Supply .....	22
2.1.1 Uncontrolled Operation .....	9	Pin 12 – Line Contactor.....	22
2.1.2 High Current Arcs .....	9	Pin 13 – Electric Brake Contactor.....	22
2.1.3 Lead Acid Batteries.....	9	Pin 14 – Power Steer Contactor .....	22
2.2 Precautions For Use.....	9	Pin 15 – +12V Supply.....	22
<b>3 Frame Dimensions.....</b>	<b>10</b>	Pin 16 – +5V Potentiometer Supply .....	22
3.1 Small Frame .....	11	6.5 Connector 'B' – Communications (8-way).....	22
3.2 Medium Frame.....	12	Pin 1 – Not Used.....	22
3.3 Large Frame.....	13	Pin 2 – Not Used.....	22
<b>4 Mounting.....</b>	<b>14</b>	Pin 3 – Flash Programming Mode (+12V).....	22
4.1 Cable Routing .....	14	Pin 4 – Flash Programmer I/O.....	22
<b>5 Wiring Guidance.....</b>	<b>15</b>	Pin 5 – CAN L .....	22
5.1 Battery and Motor Connections.....	16	Pin 6 – CAN H.....	23
5.1.1 Tightening Torque for Battery and Motor		Pin 7 – +12V Supply.....	23
Connections.....	16	Pin 8 – 0V .....	23
5.2 Battery and Motor Wire Size and Type Selection ....	17	6.6 Connector 'C' – Motor Feedback (6-way).....	23
5.3 Battery and Motor Connection Crimps		Pin 1 – Encoder Speed (A) .....	23
and Tooling.....	17	Pin 2 – Encoder Direction (B) .....	23
5.4 Control Connections .....	17	Pin 3 – Remote LED or Brake Light.....	23
5.5 Control Connection Wiring.....	17	Pin 4 – Thermistor or Steering Potentiometer .....	23
5.6 Control Connections Crimps and Tooling.....	18	Pin 5 – +12V Supply.....	24
<b>6 Connections .....</b>	<b>18</b>	Pin 6 – 0V .....	24
6.1 Battery Connection.....	18	<b>7 Electromagnetic Compatibility (E.M.C.).....</b>	<b>24</b>
6.1.1 Power Fuse.....	18	7.1 Emissions.....	24
6.1.2 Line Contactor & Pre-charge Resistor.....	18	7.1.1 Power Cables .....	24
6.1.3 Discharge Resistor.....	18	7.1.2 Signal Cables .....	24
6.1.4 Emergency Disconnect Switch .....	18	7.1.3 Controller .....	24
6.2 Motor Connections.....	19	<b>Chapter 2 – Adjustments .....</b>	<b>25</b>
6.3 Control Connections .....	19	<b>1 Adjustments .....</b>	<b>27</b>
6.4 Connector 'A' – Vehicle Interface (16-way) .....	19	1.1 Acceleration – (Accel).....	28
Pin 1 – Forward Switch.....	19	1.2 Deceleration – (Decel) .....	28
Pin 2 – Reverse Switch.....	19	1.3 Creep Speed – (Creep).....	28
Pin 3 – Footswitch / Belly Button.....	19	1.4 Maximum Forward Speed – (SpdMaxF).....	28
Pin 4 – Seat / Tiller.....	19	1.5 Maximum Reverse Speed – (SpdMaxR).....	28
Pin 5 – Speed Limit 1 / Inch Forward .....	19	1.6 Speed Limit 1 / Inching Speed	
		– (Speed 1/InchSpd) .....	28

1.7	Speed Limit 2 / Inching Time – (Speed 2/InchTime).....	29
1.8	Speed Limit 3 – (Speed 3).....	29
1.9	Direction Regen. Braking – (DBrake).....	29
1.10	Neutral Regen. Braking – (NBrake) .....	29
1.11	Footbrake Regen. Braking – (FBrake) .....	30
1.12	Direction Braking Ramp – (DBrkRamp) .....	30
1.13	Neutral Braking Ramp – (NBrkRamp).....	30
1.14	Footbrake Ramp – (FBrkRamp) .....	30
1.15	Neutral Braking End Delay – (NBrkEnd) .....	31
1.16	Sweep Speed – (SweepSpd).....	31
1.17	Maximum Current – (MaxCurr).....	31
1.18	Battery Voltage – (BattV) .....	31
1.19	Power Steering Delay – (PStrDly) .....	31
1.20	Electric Brake Delay – (EBrkDly).....	31
1.21	Accelerator 0% Voltage – (AccMin) .....	31
1.22	Accelerator 100% Voltage – (AccMax) .....	31
1.23	Footbrake 0% Voltage – (AuxMin).....	32
1.24	Footbrake 100% Voltage – (AuxMax).....	32
1.25	Steer Pot. Min. – (StrMin) .....	32
1.26	Steer Pot. Mid. – (StrMid).....	32
1.27	Steer Pot. Max. – (StrMax) .....	32
1.28	Forward Threshold – (FwdTH) .....	32
1.29	Reverse Threshold – (RevTH) .....	33
1.30	Max. Vehicle Speed – (VmaxSpd) .....	33
1.31	BDI Reset Level – (BDIreset) .....	33
1.32	BDI Empty Level – (BDIempty) .....	33
1.33	BDI Warning Level – (BDIwarn) .....	33
1.34	BDI Cut-out Level – (BDIcut).....	33
1.35	BDI Speed Limit – (BDIspeed).....	33
1.36	Dual Motor Cutback – (DMcut) .....	34
1.37	Dual Motor Angle 1 – (DMang1) .....	34
1.38	Dual Motor Angle 2 – (DMang2) .....	34
1.39	Dual Motor Angle 3 – (Dmang3).....	34
1.40	Dual Motor Speed 1 – (DMspd1) .....	34
1.41	Dual Motor Speed 2 – (DMspd2) .....	34
1.42	Dual Motor Speed 3 – (DMspd3) .....	34
1.43	Standby Delay – (StdByDly) .....	35

### Chapter 3 – Diagnostics ..... 37

1	Error Detection .....	39
2	Error Codes .....	40
3	Status .....	42
4	Further Status Information .....	43
5	Test.....	44

### Chapter 4 – Controller Set-Up..... 45

1	Controller Set-up .....	47
1.1	Accelerator Characteristic – (Lin/Curv) .....	48
1.2	Control Mode (Traction) – (Spd/Torq) .....	48
1.3	Proportional Braking – (Off/Bpro).....	48
1.4	Anti Roll-off (Hill Hold & Restraint) – (Off/Arol) .....	49
1.5	Connector A Pin 5 and 6 – (Spd/Inch) .....	49
1.6	Connector A Pin 7 – (Spd3/Hbk).....	49
1.7	Power Steering Trigger – (PsF/FR/S).....	49
1.8	Truck Type Select (Ride/Wik) .....	50
1.9	Tiller Function (TillFunc) .....	50
1.10	Display Error Indication – (Of/M/M&W).....	50
1.11	Display Status Field – (Of/D/V/K).....	50
1.12	Not Used .....	51
1.13	Motor Temperature Sensor Type – (MtempTyp).....	51
1.14	Analogue Inputs Set-up – (Accel 8/9) .....	51
1.15	Single / Dual Motor Select – (Si/DL/DR) .....	51
1.16	Remote LED / Brake Light – (RL/BL) .....	51
1.17	CAN Node Number – (CAN node).....	52
1.18	Shared Line Contactor – (ShareLC).....	52
1.19	Last Sharing Node – (LstNode).....	52

### Chapter 5 – Motor Set-up..... 53

1	Motor Set-up .....	55
1.1	Motor Temperature Cutback – (TempStrt).....	56
1.2	Motor to Vehicle Speed Ratio – (SpdRatio).....	56
1.3	Number of Teeth – (SpdTeeth).....	56
1.4	Number of Motor Poles – (SpdPoles).....	56
::	Motor Driving Set-up Explained :: .....	57
1.5	Motor Speed Minimum – (SPDmin) .....	57
1.6	Motor Speed Boost – (SPDboost).....	57
1.7	Motor Speed Base (Rated) – (SPDbase).....	58
1.8	Motor Speed Maximum – (SPDmax) .....	58
1.9	Minimum Voltage – (Vmin) .....	58
1.10	Drive Voltage Minimum – (D Vmin) .....	58
1.11	Drive Voltage Boost – (D Vboost).....	58
1.12	Drive Voltage Base (Rated) – (D Vbase).....	58
1.13	Drive Voltage Maximum – (D Vmax) .....	58
1.14	Drive Slip Minimum – (D Smin).....	58
1.15	Drive Slip Boost – (D Sboost) .....	59
1.16	Drive Slip Base – (D Sbase).....	59
1.17	Drive Slip Maximum – (D Smax) .....	59
::	Motor Braking Set-up Explained :: .....	59
1.18	Direction Braking Voltage Minimum – (BDVmin).....	60
1.19	Direction Braking Voltage Boost – (BDVboost) .....	60
1.20	Braking Voltage Base – (B Vbase) .....	60

1.21	Braking Voltage Maximum – (B Vmax) .....	60	2.1	CAN Node Set-up .....	78
1.22	Direction Braking Slip Minimum – (BDSmin) .....	60	<b>3</b>	<b>Using the Programmer .....</b>	<b>78</b>
1.23	Direction Braking Slip Boost – (BDSboost) .....	60	<b>4</b>	<b>Programmer Map .....</b>	<b>79</b>
1.24	Braking Slip Base (Rated) – (B Sbase) .....	60	4.1	Programming, Diagnostic and Test Options .....	79
1.25	Braking Slip Maximum – (B Smax).....	60	4.1.1	Adjustments .....	79
1.26	Neutral Braking Voltage Minimum – (BNVmin).....	61	4.1.2	Status .....	79
1.27	Neutral Braking Voltage Boost – (BNVboost) .....	61	4.1.3	Controller Set-up .....	79
1.28	Neutral Braking Slip Minimum – (BNSmin) .....	61	4.1.4	Motor Set-up .....	79
1.29	Neutral Braking Slip Boost – (BNSboost) .....	61	4.1.5	Test .....	79
1.30	Braking Motor Speed Base (Rated) – (BSPDbase)...	61	4.1.6	About.....	80
1.31	Proportional Gain for Voltage Change – (PgainV) .	61	<b>5</b>	<b>Diagnostics .....</b>	<b>80</b>
1.32	Proportional Gain for Outer Speed Loop – (PgainSpd) .....	61	<b>6</b>	<b>Software Upgrades .....</b>	<b>80</b>
1.33	Proportional Gain for Inner Torque Loop – (PgainTrq) .....	61	<b>Chapter 8 – Calibration .....</b>	<b>81</b>	
1.34	Ramp Delay for Inner Torque Loop – (Ramp Trq) ...	62	<b>1</b>	<b>Calibration.....</b>	<b>83</b>
1.35	Proportional Gain for Outer Speed Loop in Neutral Braking – (PgainSpN) .....	62	1.1	Load Defaults – (LoadDefs).....	83
::	Timed Current Limit Explained :: .....	62	1.2 – 1.7	Offset and Gain Settings .....	83
1.36	Current Threshold – (CurrTh) .....	62	<b>Chapter 9 – Sigmagaugage.....</b>	<b>85</b>	
1.37	Lower Maximum Current – (ImaxLow).....	62	<b>1</b>	<b>Introduction .....</b>	<b>87</b>
1.38	Threshold Timer – (lthTime) .....	63	1.1	General Information .....	87
1.39	Hill Hold Time (HHTime).....	63	1.1.1	Membrane Buttons .....	87
1.40	Hill Hold Speed – (HHSpeed).....	63	1.1.2	Battery Discharge Indicator .....	87
1.41	Hill Hold Voltage Minimum – (HHVmin).....	63	1.1.3	Fault Indication Field .....	87
1.42	Brake End Speed – (BrkEndSpd) .....	64	1.1.4	General Indication Field .....	87
			1.1.5	Hours Counter.....	87
			1.1.6	Information Field.....	87
<b>Chapter 6 – Motor Set-Up Example.....</b>	<b>65</b>		<b>2</b>	<b>Connection .....</b>	<b>88</b>
<b>1</b>	<b>Example Set-up Procedure .....</b>	<b>67</b>	<b>3</b>	<b>Mounting .....</b>	<b>88</b>
1.1	Drive speed set-up .....	67	<b>4</b>	<b>Configuring the Sigmagaugage .....</b>	<b>89</b>
1.2	Drive voltage set-up .....	68	<b>Chapter 10 – Technical Specifications.....</b>	<b>91</b>	
1.3	Drive slip set-up.....	68	<b>1</b>	<b>Electrical.....</b>	<b>93</b>
1.4	Motor set-up – Braking .....	69	1.1	Voltage Specifications.....	93
1.5	Defining the Braking Motor Speed Base Point .....	69	1.2	Current Specifications.....	93
1.6	Brake Slip Set-up .....	70	<b>2</b>	<b>Environmental.....</b>	<b>93</b>
1.7	Brake Voltage Set-up .....	70	<b>3</b>	<b>Mechanical .....</b>	<b>94</b>
1.8	Braking Percentage Levels.....	71			
1.9	Fine-tuning Drive .....	71			
1.10	Additional Torque.....	71			
1.11	The Results After Fine-tuning.....	71			
1.12	Fine-Tuning Braking .....	72			
<b>Chapter 7 – Hand-Held Programmer.....</b>	<b>75</b>				
<b>1</b>	<b>Introduction.....</b>	<b>77</b>			
1.1	Interface Switch .....	77			
<b>2</b>	<b>Connection.....</b>	<b>78</b>			

## About this manual

This manual is divided into 10 chapters.

Chapter 1 – Installation

This chapter deals with the mounting, connection and wiring of the Sigmadrive.

Chapter 2 – Adjustments

This chapter deals with the Sigmadrive's 'Adjustments' parameters.

Chapter 3 – Diagnostics

This chapter provides an overview of the diagnostic capabilities of the Sigmadrive range.

Chapter 4 – Controller Set-up

This chapter deals with the Sigmadrive's 'Controller Set-up' parameters.

Chapter 5 – Motor Set-up

This chapter deals with the Sigmadrive's 'Motor Set-up' parameters.

Chapter 6 – Motor Set-up Example

This chapter provides a typical motor set-up guide for the Sigmadrive.

Chapter 7 – Hand-held Programmer

This chapter provides an overview of the Sigmadrive Hand-held Programmer.

Chapter 8 – Calibration

This chapter deals with the Sigmadrive's 'Calibration' parameters.

Chapter 9 – Sigmagauge

This chapter provides an overview of the Sigmagauge.

Chapter 10 – Technical Specifications

This chapter provides a summary of the Sigmadrive's Technical Specifications.

## Icons

Throughout this manual, icons are used to draw the reader's attention.

The icons used are:



**Note** – A general point for best practice.



**Caution** – A point of safety which if ignored could result in damage to the control system or the vehicle.



**Warning** – A point of safety which if ignored could cause injury to the individual.

PG Drives Technology accepts no liability for any losses of any kind if these points are not followed.



## CHAPTER I – INSTALLATION





## I Introduction

The Sigmadrive is an advanced digital controller for all popular motor types and is designed for electric vehicle applications such as Industrial Trucks, Personnel Carriers, Golf Cars, Aerial Work Platforms and Materials Handling Equipment.

Advanced drive algorithms are employed to ensure smooth, accurate, predictable and efficient control of vehicle speed and torque. Motor reversing and regenerative braking in both directions is achieved via solid-state electronics.

The Sigmadrive has been designed to easily withstand the harsh operating environments that electric vehicles typically endure. State-of-the-art construction techniques ensure the controller can withstand shock, vibration and extremes of temperature. To ensure the Sigmadrive installation is as robust as possible, follow the guidelines in this manual.

## 2 Guidelines For Working On Electric Vehicles

### 2.1 Precautions For Working On Electric Vehicles

Working on any electrical system can be dangerous. Work on electric vehicles should only be undertaken by skilled or supervised persons, in a segregated location that eliminates the risk of injury to other persons. Before performing any kind of work on electric vehicles, ensure that the following basic safety advice is followed.

#### 2.1.1 Uncontrolled Operation

Fault conditions or programming changes may cause the motor to run out of control. Disconnect the motor or raise the drive wheels above the ground. If lifting the vehicle, use the correct jacking procedure as recommended by the vehicle manufacturer to lift the vehicle's drive wheels clear of the ground. Once lifted, fit axle stands to safely support the vehicle and remove the jack. Ensure that all such lifting equipment is in serviceable condition and suitable for the vehicle in question.

#### 2.1.2 High Current Arcs

Batteries contain very high levels of energy and can be extremely dangerous if mishandled or abused. Always disconnect the batteries before working on the vehicle's electrical system and the motor controller wiring. Remove all jewellery from wrist and fingers and use properly insulated tools to prevent shorts. Wear safety glasses at all times.

#### 2.1.3 Lead Acid Batteries

Charging or discharging lead acid batteries generates hydrogen gas, which can build up in and around the battery area. Ensure charging is performed in a ventilated area. Follow the battery manufacturer's safety recommendations. Wear safety glasses at all times.

### 2.2 Precautions For Use

Do not drive the vehicle:

- Beyond restrictions indicated in your vehicle user manual, for example inclines, curb heights etc.
- In places or on surfaces where a loss of wheel grip could be hazardous, for example on wet grassy slopes.
- If you know that the controller or other crucial components require repair.



Although the controller is designed to be extremely reliable and each unit is rigorously tested during manufacture, the possibility of system malfunction always exists (however small the probability). Under some conditions of system malfunction the controller must (for safety reasons), stop the vehicle instantaneously. If there is any possibility of the user falling out of the vehicle as a result of a sudden braking action, it is imperative that a restraining device such as a seat belt is supplied with the vehicle and that it is in use at all times when the vehicle is in motion. PGDT accept no liability for losses of any kind arising from the unexpected stopping of the vehicle, or arising from the improper use of the vehicle or controller.



Do not operate the controller if the vehicle behaves erratically, or shows abnormal signs of heating, sparks or smoke. Turn the controller off at once and consult your service agent. PGDT accepts no liability for losses of any kind arising from failure to comply with this condition.



Electronic equipment can be affected by Electro Magnetic Interference (EMI). Such interference may be generated by radio stations, TV stations, other radio transmitters and cellular phones. If the vehicle exhibits erratic behavior due to EMI, turn the controller off immediately and consult your service agent. PGDT accepts no liability for losses of any kind arising from failure to comply with this condition.



It is the responsibility of the vehicle manufacturer to ensure that the vehicle complies with appropriate National and International EMC legislation. PGDT accepts no liability for losses of any kind arising from failure to comply with this condition.



The vehicle user must comply with all vehicle safety warnings. PGDT accepts no liability for losses of any kind arising from failure to comply with this condition.

### 3 Frame Dimensions

The Sigmadrive is constructed in three frame sizes – small, medium or large. This can be identified from the last character of the product code. For example, ACT425\$ is a \$small frame size.

### 3.1 Small Frame

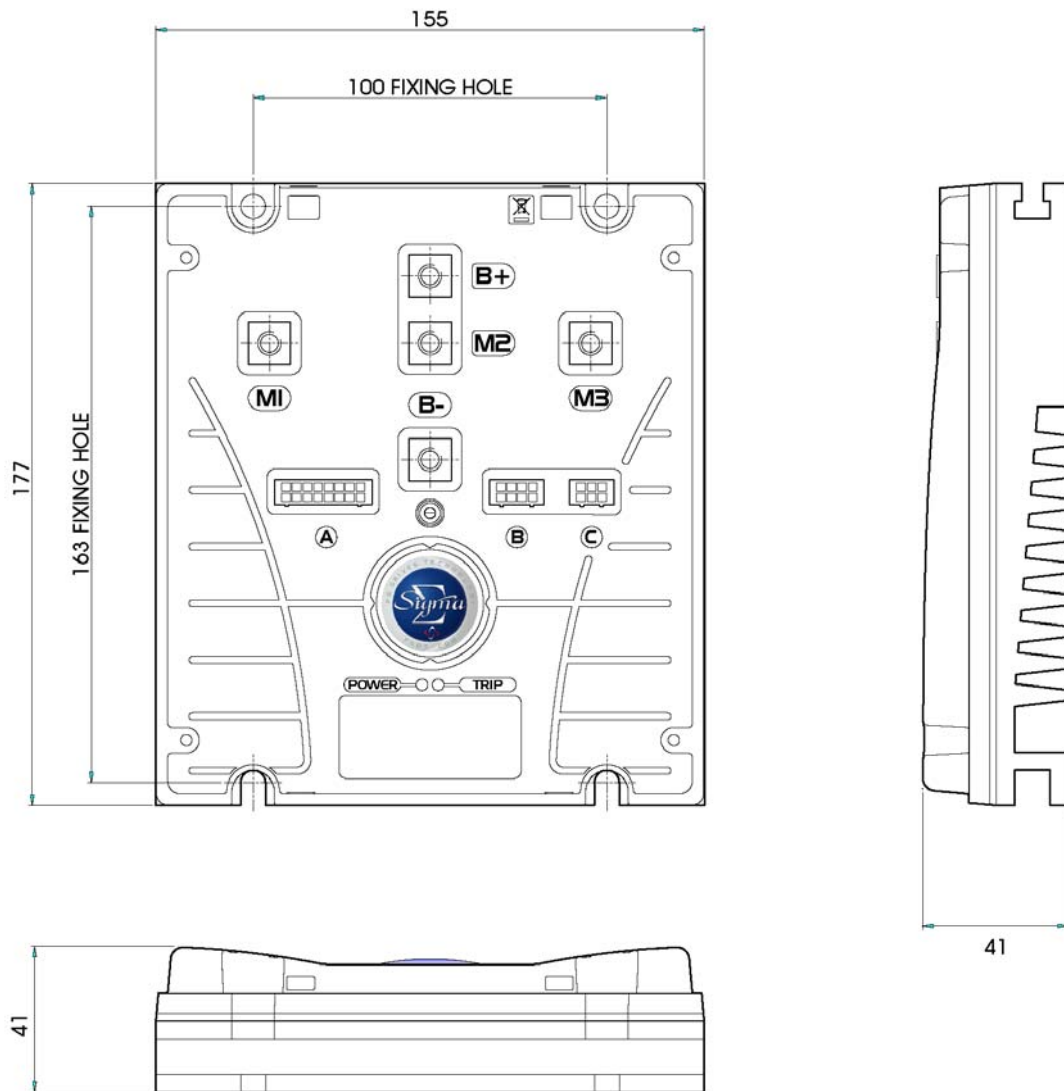

### 3.2 Medium Frame

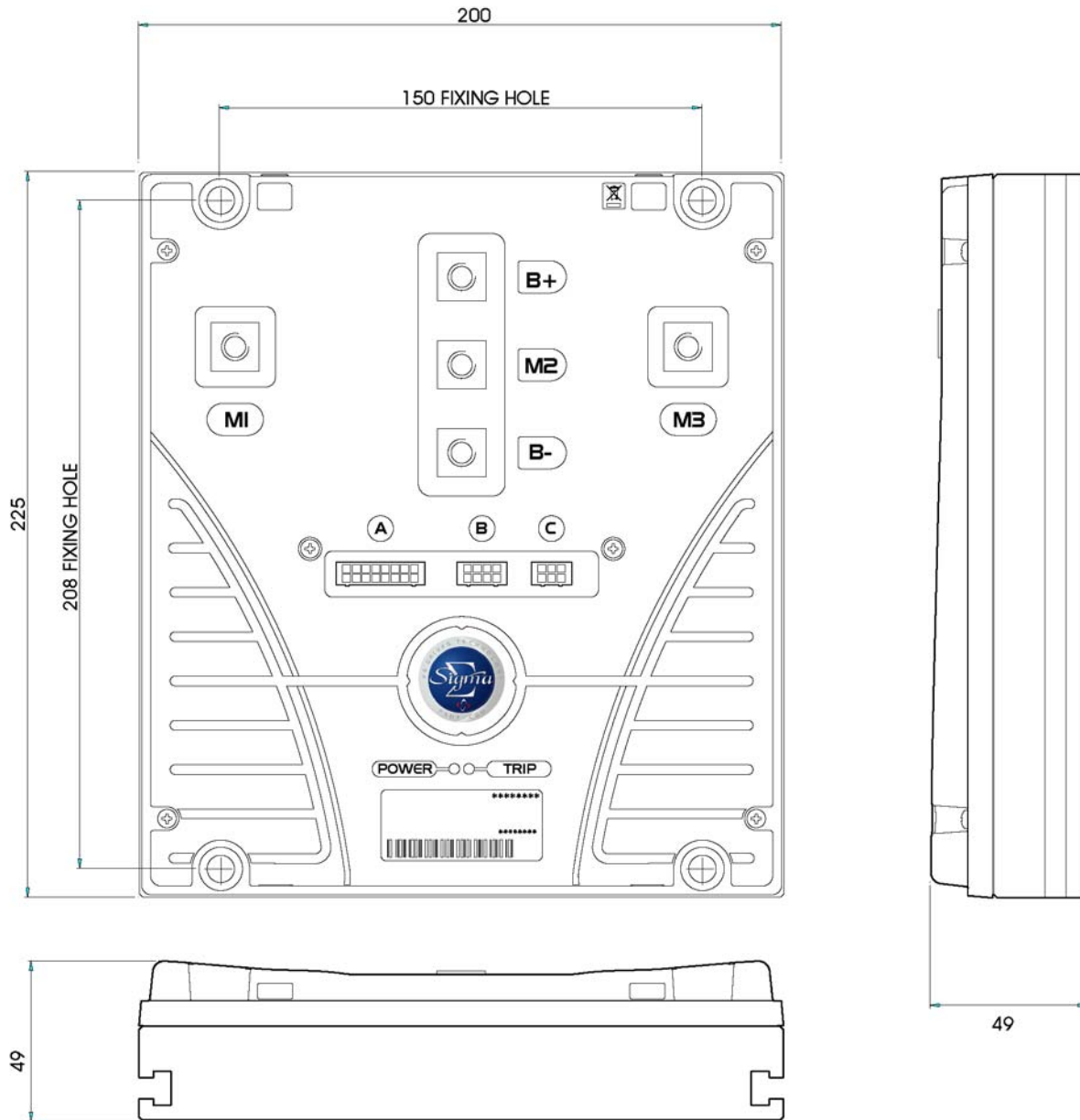

### 3.3 Large Frame

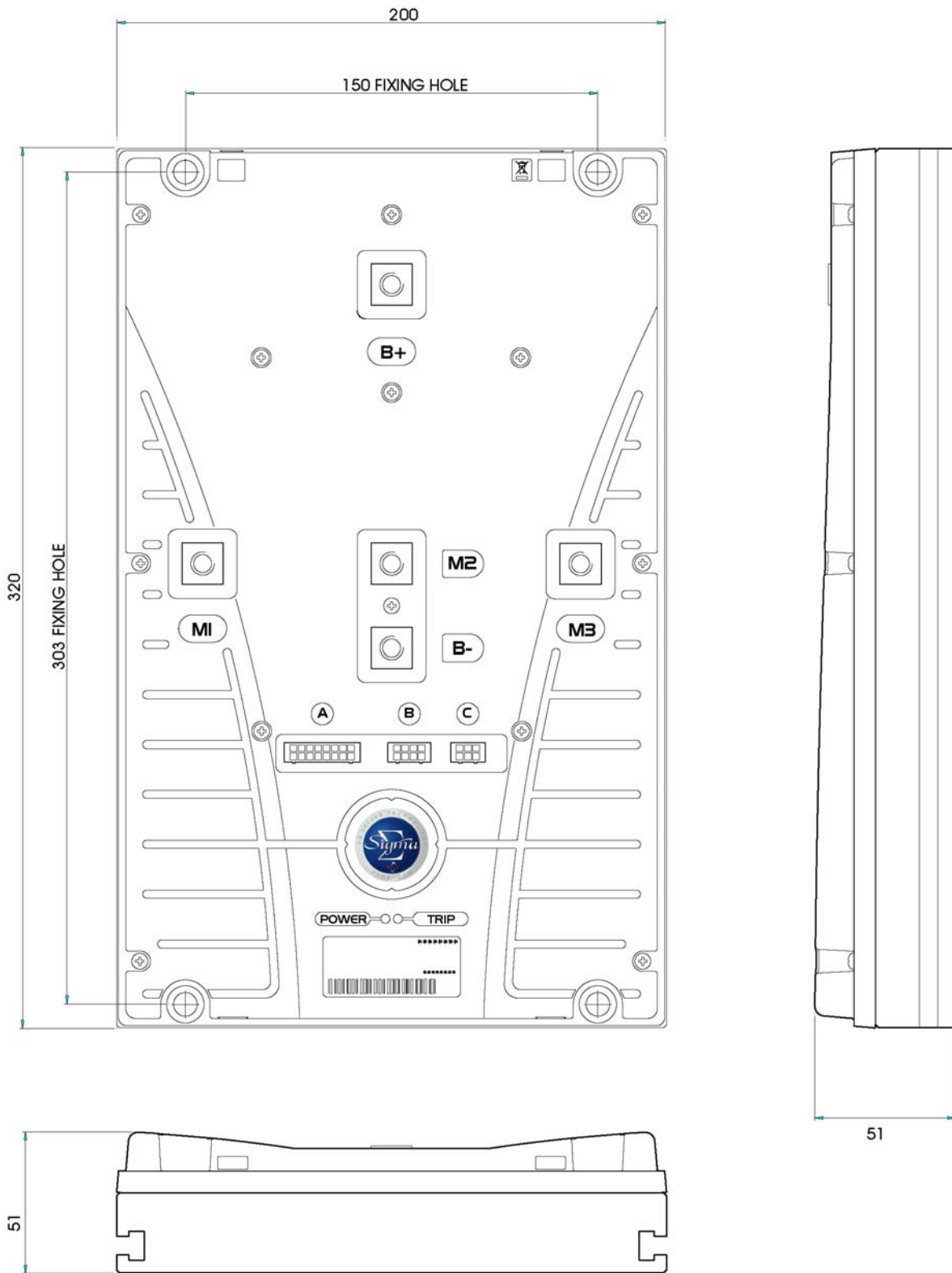

## 4 Mounting

Careful consideration should be given to the location chosen to mount the controller. Although the Sigmadrive benefits from excellent environmental protection, it is good engineering practice for the selected position to be clean and dry, to minimize shock, vibration, temperature changes and exposure to water & contaminants.

If vertical orientation mounting is not possible, then a cover should be used to shield the controller. Cables must be routed to prevent liquids flowing into the connections. The mounting position should also allow access to all connections and allow the connection and removal of a programming device.

Secure the controller to the vehicle via the four clearance holes provided. Ideally, a flat clean metal surface will provide maximum heat dissipation and ensure full rated power output. Failure to use all four mounting points may result in a loss in performance. Any airflow around the controller will further enhance the thermal performance. If desired, the controller's thermal performance may be further improved by applying a silicone-free thermal compound between the baseplate and the machine chassis.

The Small Frame controller has M6 (1/4") clearance holes.

The Medium and Large Frame controllers have M8 (5/16") clearance holes.



**Under strenuous driving conditions, it is possible for metal sections of the controller's case to exceed 41°C (106 °F). Under such conditions, the machine manufacturer should ensure that either the user cannot touch these surfaces, or that the user is warned not to touch these surfaces. While 41°C (106 °F) is very close to normal body temperature, prolonged contact with surfaces above 41°C (106 °F) can result in burns to the skin. PGDT accepts no liability for losses of any kind arising from failure to comply with this condition.**

### 4.1 Cable Routing

The cables to the controller must be routed and secured in such a way as to prevent damage, for example by chafing or crushing, or exposure to solvents or other chemicals that may degrade the insulation. It is suggested that the cables are mounted so that they loop up to the controller, therefore minimizing the flow of moisture into the connectors. Route wiring to keep lengths as short as possible, especially the high current motor and battery cabling.

## 5 Wiring Guidance

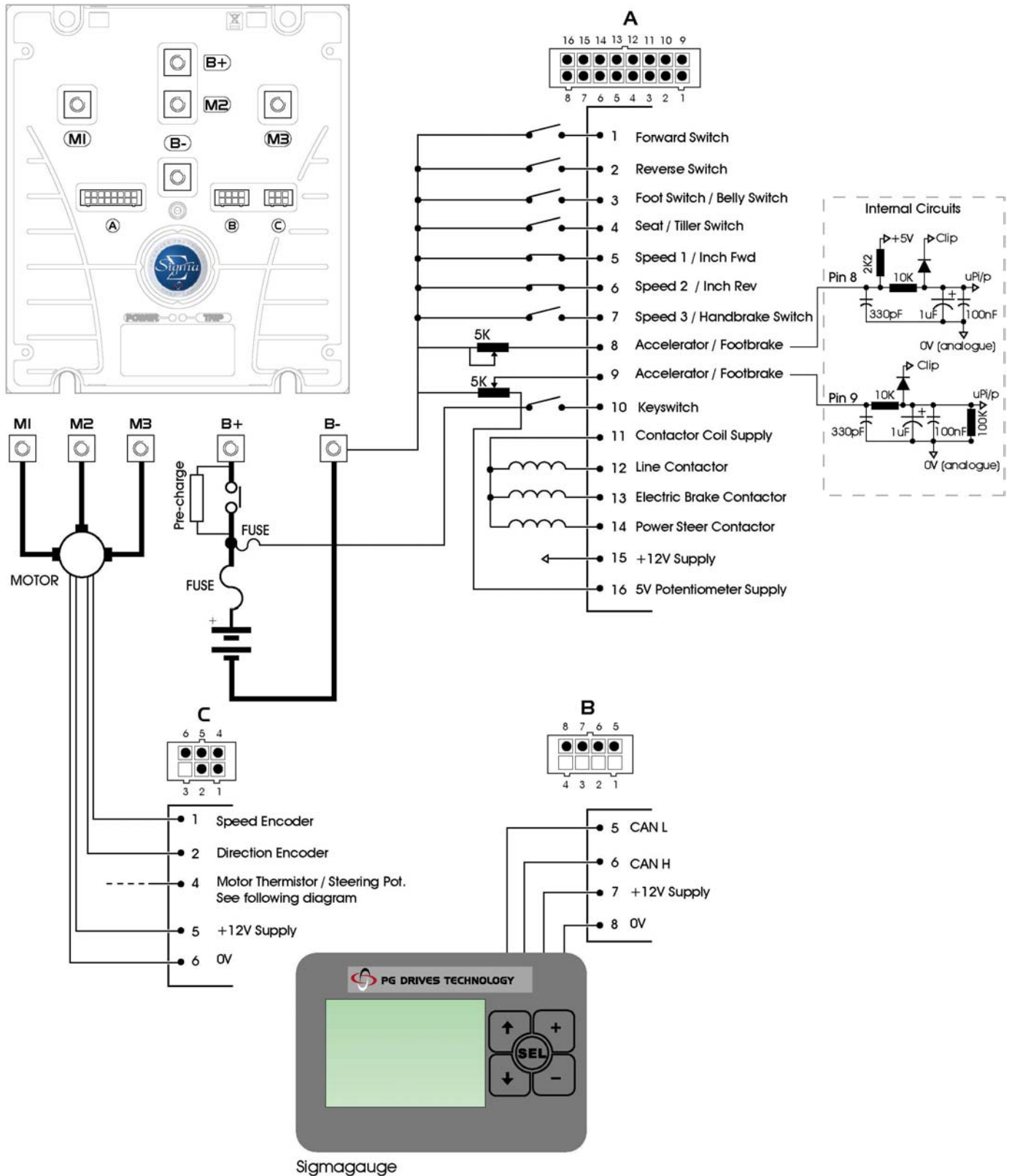

## Steering Potentiometer Wiring

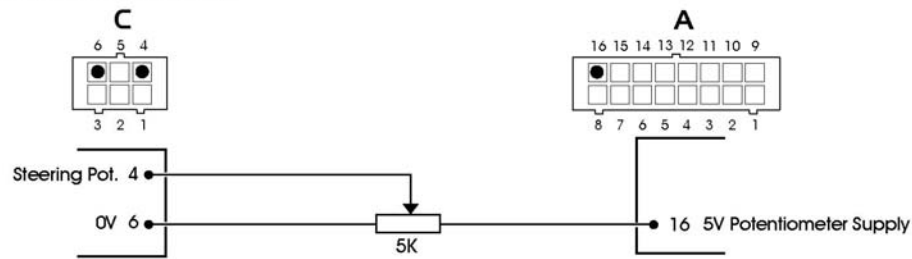

## Motor Thermistor Wiring

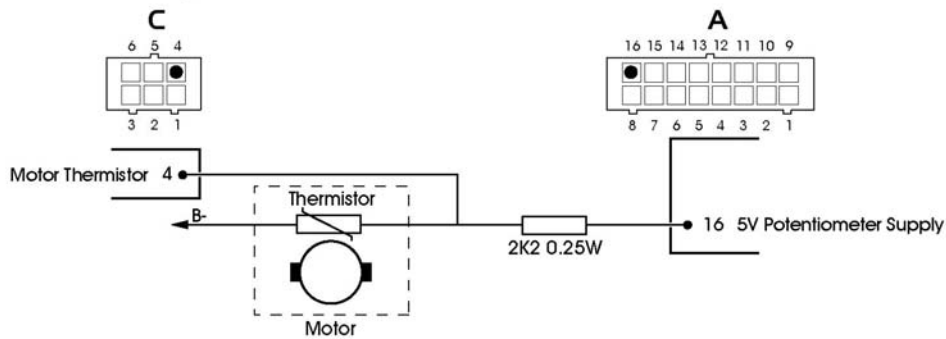

## 5.1 Battery and Motor Connections

Five copper terminals with threaded holes are provided for the high current connections. These are identified as B+, B-, M1, M2 and M3. The controller is provided with suitable screws, spring washers and flat washers for fastening the battery and motor cables. PGDT recommends the arrangement of screw, spring washer and flat washer as shown below for the correct termination of the high power connectors.

The small frame size has M6 threaded holes, while the medium and large frame sizes have M8 threaded holes.

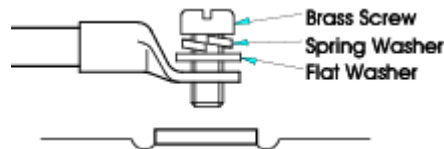

**If alternate screws or bolts are used, it is essential that the thread insertion depth is less than 14mm. Damage to the controller may occur if this depth is exceeded.**



**After securely fitting the high current cables, do not put undue upward pressure on them by twisting or pulling – this may result in damage to the terminal pillars. If the cable position needs to be readjusted, loosen the screw and washer arrangement first.**

### 5.1.1 Tightening Torque for Battery and Motor Connections

The medium and large frame sizes use M8 screws and these should be tightened to 11Nm.

The small frame size uses M6 screws and these should be tightened to 9Nm.



## 5.2 Battery and Motor Wire Size and Type Selection

The wiring arrangement used on a particular vehicle can greatly affect the current carrying capacities of individual wires. Ambient temperature, grouping and wire length can all significantly de-rate cable performance and other factors such as vehicle duty cycles and airflow should also be taken into consideration when selecting vehicle wiring.

PGDT recommends the use of BS6231 (UL 1015, 1028, 1283 or 1284 dependent on wire gauge), Tri-rated wire due to its superior flexibility and 90/105°C temperature rating. The table below shows the minimum recommended wire sizes for the various connections on the Sigmadrive controllers.

Frame Size	Motor	Battery
Small	16 mm <sup>2</sup>	16 mm <sup>2</sup>
Medium	35 mm <sup>2</sup>	35 mm <sup>2</sup>
Large	70 mm <sup>2</sup>	70 mm <sup>2</sup>



**It is the responsibility of the vehicle manufacturer to ensure that the vehicle's wiring arrangement is suitable for the intended application, and complies with all necessary standards that are dictated by the relevant approvals of regulatory organizations. PGDT accepts no liability for losses of any kind arising from an inappropriate wiring arrangement.**

## 5.3 Battery and Motor Connection Crimps and Tooling

Good quality crimping is essential in ensuring the long-term reliability of the vehicle's electrical system. Poor quality crimps may initially appear satisfactory, but can deteriorate over time, ultimately causing the vehicle to break down. For the battery and motor connections, the use of AMP® AMPower III™ or Solistrand™ copper tube leg terminals is recommended. It is absolutely vital that the selected crimp terminal is designed to be used with the wire size and type being used.

It is also vital that for the selected crimp terminal the correct tooling is used for its installation onto the wire, and that the procedure for doing so is followed correctly. Contact the crimp terminal manufacturer to ensure that the tooling employed is suitable for use with the chosen combination of wire and crimp terminal.

If insulated crimps are used, ensure the insulation is firmly pushed into place. If uninsulated crimps are used, it is recommended that heatshrink or similar sleeving is used to insulate the barrel of the crimp terminal.



**Ensure that only fully trained and skilled operators perform the crimping procedure and that the instructions provided by the crimp terminal manufacturer are followed. PGDT accepts no liability for losses of any kind if the recommendations made in this section are not followed.**

## 5.4 Control Connections

The low current control connections on the Sigmadrive are via Molex® SMD Micro Fit 3.0 Series connectors. These connectors are labeled as A, B and C on the cover of the controller and provide the following functions.

- A      16-way Vehicle Interface Connector
- B      8-way Communications Connector
- C      6-way Motor Feedback Connector

## 5.5 Control Connection Wiring

Use 0.5mm<sup>2</sup>/18AWG wire gauge for all control connections. It is also recommended that Tri-rated wire with a 105°C insulation rating is used.

## 5.6 Control Connections Crimps and Tooling

The following table shows the Molex part numbers for the mating crimps, housings, crimp tool and extraction tool.

Alternatively, the mating connectors can be purchased directly from PGDT using the connector kit part numbers shown.

Connector	PGDT Connector Kit Part No.	Molex Housing Part No.	Molex Crimp Part No.	Molex Crimp Tool Part No.	Molex Extraction Tool Part No.
A – 16-way	D51066	43025-1600	43030-0007	69008-0982	11-03-0043
B – 8-way	D51068	43025-0800	43030-0007		
C – 6-way	D51067	43025-0600	43030-0007		



**PGDT recommends that only genuine Molex parts should be used. Inferior quality crimps or incorrect tooling can seriously reduce the reliability and longevity of the controller or vehicle. PGDT accepts no liability for losses of any kind if non-recommended parts are used.**

## 6 Connections

### 6.1 Battery Connection

Connect the positive supply to the B+ terminal and the negative supply to the B- terminal.

#### 6.1.1 Power Fuse

A suitable fuse must be fitted to the battery positive supply. This fuse should be fitted as closely as possible to the battery's positive terminal.

#### 6.1.2 Line Contactor & Pre-charge Resistor

A suitable line contactor must be connected to the battery positive supply. This should be fitted with a 5W 10kΩ pre-charge resistor connected in parallel across the contacts. The coil of the line contactor can be controlled by the Sigmadrive, via pin 12 of Connector A.

#### 6.1.3 Discharge Resistor

Units manufactured before October 2008 require an external discharge resistor. The resistor should be fitted between the Sigmadrive's B+ and B- terminals. The correct value for each controller model is shown below.

24V only Sigmadrive – 10kΩ 1/4W

24V – 48V Sigmadrive – 22kΩ 1/4W

72V – 80V Sigmadrive – 47kΩ 1/4W

#### 6.1.4 Emergency Disconnect Switch

For certain vehicle types, safety legislation requires that an emergency battery disconnect switch or switches should be fitted in the battery positive supply, in order to allow complete isolation of the vehicle's electrical system from the battery. The location of this switch or switches should be as stipulated in the appropriate legislative documentation.



**It is the responsibility of the vehicle manufacturer to ensure appropriate fuses, line contactors and emergency disconnect switches are used and that these devices are appropriately located. PGDT accepts no liability for losses of any kind if inappropriate devices or arrangements are used.**

## 6.2 Motor Connections

The three motor connections are marked M1, M2 and M3. There is no convention as to how these relate to the phase windings on individual motors, so the controller to motor connections are arbitrary. If, when a forward command is applied, the vehicle drives in reverse, swap any two of the motor connections.

## 6.3 Control Connections

The control connections are via three connectors with pin-outs as follows.

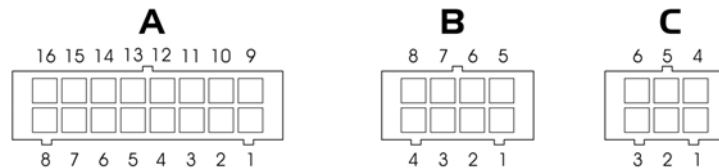

Connector A: Vehicle Interface

Connector B: Communications to display module and/or programmer

Connector C: Motor Feedback

Details of the functions of each of the pins for these connectors are shown in the following section.

### 6.4 Connector 'A' – Vehicle Interface (16-way)

#### Pin 1 – Forward Switch

This switch must be closed in conjunction with the Accelerator to give a forward drive signal.

#### Pin 2 – Reverse Switch

This switch must be closed in conjunction with the Accelerator to give a reverse drive signal.

#### Pin 3 – Footswitch / Belly Button

The function of this input is set by the programmable parameter, 3.8 Truck Type Select.

If set to Ride, then the vehicle's Footswitch should be connected to this pin, and must be closed to allow drive.

If set to Wlk, then the vehicle's Belly Button switch should be connected to this pin. When the Belly Button switch is closed, the vehicle will drive in the opposite direction for 1.5s.

#### Pin 4 – Seat / Tiller

The function of this input is to provide a general safety interlock. This could be a Seat switch on a ride-on vehicle, a Tiller switch on a "walkie" vehicle or a general deadman's trigger on other vehicle types. The switch must be closed to allow drive.

#### Pin 5 – Speed Limit 1 / Inch Forward

The function of this input is set by the programmable parameter, 3.5 Connector A Pin 5 and 6.

If set to Spd, then this input can be used to limit the speed of the vehicle to a value set by the programmable parameter, 1.6 Speed Limit 1. The speed limit will occur when the switch is open.

If set to Inch, then this input is used to “inch” the vehicle in the forward direction. Inching will occur when the switch is closed. The exact functionality of inching is set by the programmable parameters, 1.6 Inching Speed and 1.7 Inching Time.

### Pin 6 – Speed Limit 2 / Inch Reverse

The function of this input is set by the programmable parameter, 3.5 Connector A Pin 5 and 6.

If set to Spd, then this input can be used to limit the speed of the vehicle to a value set by the programmable parameter, 1.7 Speed Limit 2. The speed limit will occur when the switch is open.

If set to Inch, then this input is used to “inch” the vehicle in the reverse direction. Inching will occur when the switch is closed. The exact functionality of inching is set by the programmable parameters, 1.6 Inching Speed and 1.7 Inching Time.

### Pin 7 – Speed Limit 3 / Handbrake

This input is primarily intended to be used with a handbrake switch, however, its function can be set by the programmable parameter, 3.6 Connector A Pin 7.

If set to Spd3, then this input can be used to limit the speed of the vehicle to a value set by the programmable parameter, 1.8 Speed Limit 3. The speed limit will occur when the switch is open.

If set to Hbk, then this input should be connected to the vehicle’s handbrake switch. When the switch is closed, i.e. the handbrake is on, the vehicle’s speed will be as set by the programmable parameter, 1.8 Speed Limit 3.

### Pin 8 – Accelerator / Footbrake

This is an analogue input that will accept a 2-wire 5k $\Omega$  potentiometer or a 0V to 5V voltage signal.

The function of this input is set by the programmable parameter, 3.14 Analogue Inputs Set-up.

If set to 0, then this input should be connected to the vehicle’s Accelerator device.

If set to 1, then this input should be connected to the vehicle’s Footbrake device.

If set to 2, then this input will not be used.

When set to 0, the active range of the accelerator input is defined by the programmable parameters, 1.21 Accelerator 0% Voltage and 1.22 Accelerator 100% Voltage. The former parameter sets the voltage that relates to zero drive demand from the Accelerator, while the latter parameter sets the voltage that relates to 100% drive demand from the Accelerator.

When set to 1, the active range of the footbrake input is defined by the programmable parameters, 1.23 Footbrake 0% Voltage and 1.24 Footbrake 100% Voltage. The former parameter sets the voltage that relates to zero braking demand from the Footbrake, while the latter parameter sets the voltage that relates to 100% braking demand from the Footbrake.

If a Footbrake switch is used on the brake pedal instead of an analogue device, the switch should connect this input to the voltage corresponding to the value of parameter, 1.24 Footbrake 100% Voltage, in order to effect full braking.

### Pin 9 – Accelerator / Footbrake

This is an analogue input that will accept a 3-wire 5k $\Omega$  potentiometer or a 0V to 5V voltage signal.

The function of this input is set by the programmable parameter, 3.14 Analogue Inputs Set-up.

If set to 0, then this input should be connected to the vehicle’s Footbrake device.

If set to 1, then this input should be connected to the vehicle’s Accelerator device.

If set to 2, then this input should be connected to the vehicle’s Wig-Wag Throttle device.



**If a Wig-Wag Throttle Type device is to be connected to this pin, additional 1k $\Omega$  resistors should be fitted between the potentiometer and its supplies, as shown below.**

Throttle Potentiometer Wiring

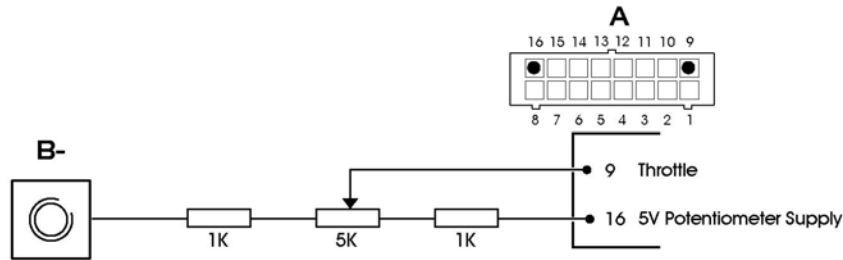

When set to 0, the active range of the footbrake input is defined by the programmable parameters, 1.23 Footbrake 0% Voltage and 1.24 Footbrake 100% Voltage. The former parameter sets the voltage that relates to zero braking demand from the Footbrake, while the latter parameter sets the voltage that relates to 100% braking demand from the Footbrake.

If a Footbrake switch is used on the brake pedal instead of an analogue device, the switch should connect this input to the voltage corresponding to the value of parameter, 1.24 Footbrake 100% Voltage, in order to effect full braking.

When set to 1, the active range of the accelerator input is defined by the programmable parameters, 1.21 Accelerator 0% Voltage and 1.22 Accelerator 100% Voltage. The former parameter sets the voltage that relates to zero drive demand from the Accelerator, while the latter parameter sets the voltage that relates to 100% drive demand from the Accelerator.

When set to 2, the active range of the throttle input is defined by the programmable parameters, 1.21 Accelerator 0% Voltage, 1.22 Accelerator 100% Voltage, 1.28 Forward Threshold and 1.29 Reverse Threshold. Parameter 1.21 sets the voltage that relates to 100% reverse drive demand from the Throttle, while parameter 1.22 sets the voltage that relates to 100% forward drive demand from the Throttle. Parameters 1.28 and 1.29 set the neutral 'dead band'.



**If the operation of the wig-wag pot is reversed, swap the two supply leads of the potentiometer. Transposing the parameter values will result in a fault.**

Since a wig-wag configuration does not include a separate switch wired to Connector A pin 3, 1kΩ series resistors should be fitted as shown in the Throttle Potentiometer Wiring diagram to provide 'wire-off' protection.



**You must only use a 5kΩ wig-wag potentiometer with the 1kΩ resistors.**

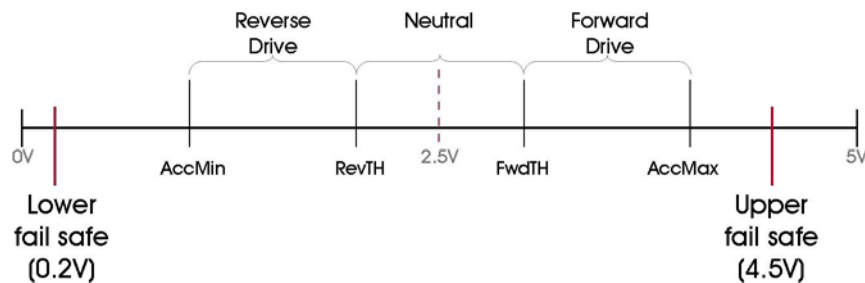

Pin IO – Keyswitch

This input should be connected to the switched side of the keyswitch. The other side of the keyswitch should be connected to the battery positive supply.

A fuse of sufficient value to supply all contactor coil currents should be connected between the battery positive supply and the keyswitch. The position of the fuse should be as close as possible to the tap-off point for the keyswitch supply.

**Pin 11 – Contactor Coil Supply**

This output is the positive supply to the vehicle's contactors. The voltage level of this supply corresponds to the vehicle's battery voltage. The maximum supply current from this pin is 3A.

**Pin 12 – Line Contactor**

This pin should be connected to the negative side of the Line Contactor coil. The Sigmadrive will control the Line Contactor as required. The maximum rating for this connection is 3A and it is fully protected for use with inductive loads.

**Pin 13 – Electric Brake Contactor**

This pin should be connected to the negative side of the Braking Contactor coil. The Sigmadrive will control the Braking Contactor as required. The maximum rating for this connection is 3A and it is fully protected for use with inductive loads.

**Pin 14 – Power Steer Contactor**

This pin should be connected to the negative side of the Power Steer Contactor coil. The Sigmadrive will control the Power Steer Contactor as required. The maximum rating for this connection is 3A and it is fully protected for use with inductive loads.



**An external contactor driver is required when using pin 14 on small frame Sigmadrive controllers. Please contact PGDT for further information if a Power Steer Contactor is required for this size of Sigmadrive.**

**Pin 15 – +12V Supply**

A 12V supply. The maximum supply current is 20mA from this pin.

**Pin 16 – +5V Potentiometer Supply**

A supply for the 5k $\Omega$  Accelerator, Footbrake or Throttle potentiometer connected to pin 9.

**6.5 Connector 'B' – Communications (8-way)****Pin 1 – Not Used**

Not used.

**Pin 2 – Not Used**

Not used.

**Pin 3 – Flash Programming Mode (+12V)**

For use with the Flash Programmer.

**Pin 4 – Flash Programmer I/O**

For use with the Flash Programmer.

**Pin 5 – CAN L**

CAN Low communications line to the Programming Device, Display or other Controller(s).

**Pin 6 – CAN H**

CAN High communications line to the Programming Device, Display or other Controller(s).

**Pin 7 – +12V Supply**

A 12V supply. The maximum supply current is 20mA from this pin.

**Pin 8 – 0V**

A 0V supply for the Programming Device or Display.

**6.6 Connector 'C' – Motor Feedback (6-way)****Pin 1 – Encoder Speed (A)**

Connect to the speed signal of the motor encoder.

**Pin 2 – Encoder Direction (B)**

Connect to the direction signal of the motor encoder.



The motor encoder is normally a 'Quadrature' type, which has 2 outputs, 'A' and 'B'. Both outputs produce a symmetrical square wave, with A leading B by 90°. These outputs can be used to deduce both the direction and speed of the motor. If A is 'high' when B is 'low', the motor is rotating forwards and conversely, if A is low when B is high, the motor is rotating in reverse. Traditionally, Channel A is referred to as the speed signal, indicating the number of pulses per second, whilst Channel B is normally referred to as the Direction signal, indicating motor forward or reverse.

**Pin 3 – Remote LED or Brake Light**

The function of this output is set by the programmable parameter, 3.16 Remote LED / Brake Light.

If set to 0, then this output may be used to drive a remote LED, which can function as an external fault indicator.

If set to 1, then this output may be used to drive a brake light. The brake light will only be active during Footbraking.



**An external 'driver module' must be connected to operate either an LED or Brake Light.**

**Pin 4 – Thermistor or Steering Potentiometer**

The function of this input is set by the programmable parameter, 3.15 Single / Dual Motor Select, in the Controller Set-up menu.

If set to 0 (Motor Temperature), then this input can be connected to an external thermistor, typically on the motor, which can be used to reduce controller current output with respect to temperature. The type of thermistor is set by the parameter, 3.13 Motor Temperature Sensor Type. Once the correct sensor type has been set, the parameter, 4.1 Motor Temperature Cutback, can then be used to set the temperature at which current foldback will begin. In addition to the thermistor, a 2.2kΩ 0.25W 'pull-up' resistor should be connected between this pin and a 5V supply – a convenient connection point can be found on pin 16 of Connector A.

If set to either 1 (Dual Motor Left) or 2 (Dual Motor Right), then this input can be connected to a 3-wire 5kΩ potentiometer that measures the steering angle of the vehicle. Refer to the Wiring Guidance diagram for connection details.

The active range of the input when used by a steering potentiometer is defined by the parameters, 1.25 Steer Pot. Min., 1.26 Steer Pot. Mid. and 1.27 Steer Pot. Max. 1.25 Steer Pot. Min. sets the voltage that relates to the minimum (full left hand lock) steering angle, while 1.27 Steer Pot. Max. sets the voltage that relates to the maximum (full right hand lock) steering angle. 1.26 Steer Pot. Mid. corresponds to a 0° steering angle, i.e. the vehicle performs no steering operation.

### Pin 5 – +12V Supply

A 12V supply with a maximum current of 20mA. This output can be used for the motor encoder supply.

### Pin 6 – 0V

A 0V connection point for the Speed Encoder and Steering Potentiometer.



**Avoid routing the 6-way motor feedback cables close to the motor power cables - they must not be tie-wrapped together. If screened cable is used, contact PGDT for details on how to connect this at the motor and controller ends. This is critical to help avoid any noise or incorrect speed measurement issues.**

## 7 Electromagnetic Compatibility (E.M.C.)

You should consider EMC and perform relevant tests as early as possible in the design phase.

### 7.1 Emissions

Any high-speed switch is capable of generating harmonics at frequencies that are many multiples of its basic operating frequency. It is the objective of a good installation to contain or absorb the resultant emissions. All wiring is capable of acting as a receiving or transmitting antenna. Wiring should be arranged to take maximum advantage of the structural metal work inherent in most vehicles. Vehicle metalwork should be electrically linked with conductive braids.

#### 7.1.1 Power Cables

All cables should be routed within the vehicle framework and kept as low in the structure as is practical; a cable run within a main chassis member is better screened from the environment than one routed through or adjacent to an overhead guard. Power cables should be kept short to minimize emitting and receiving surfaces. Shielding by the structure may not always be sufficient; cables run through metal shrouds may be required to contain emissions.

Parallel runs of cables in common circuits can serve to cancel emissions, e.g. the battery positive and negative cables following similar paths.

Tie all cables into a fixed layout and do not deviate from the approved layout in production vehicles. A re-routed battery cable could negate any approvals obtained.

#### 7.1.2 Signal Cables

All wiring harnesses should be kept short. Wiring should be routed close to the vehicle metalwork. All signal wires should be kept clear of power cables or made from screened cable. This is particularly important if the control wiring carries analogue information, e.g. Accelerator wiring. Tie all wiring securely and ensure it always follows the same layout.

#### 7.1.3 Controller

Thermal and EMC (emissive) requirements tend to work in opposition. Additional insulation between the controller assembly and the vehicle framework reduces capacitive coupling and hence emissions but tends to reduce the thermal performance. A working balance needs to be established by experiment. The complete installation should be documented in detail and faithfully reproduced on all production vehicles. When making changes, consider their effect on compliance, ahead of other factors such as cost reduction.





## CHAPTER 2 – ADJUSTMENTS



## I Adjustments

The Sigmadrive Programmer 'Adjustments' menu (1. Adjustments), contains the parameters shown in the table below. Each parameter has a unique reference number, 1.x, as shown in the left-hand column. The parameter name as it appears on the Programmer screen and parameter range are also shown.

Ref.	Parameter	Programmer Text	Range
1.1	Acceleration	Accel	0.1s – 10.0s
1.2	Deceleration	Decel	0.1s – 10.0s
1.3	Creep Speed	Creep	0Hz – 63Hz
1.4	Maximum Forward Speed	SpdMaxF	0Hz – 255Hz
1.5	Maximum Reverse Speed	SpdMaxR	0Hz – 255Hz
1.6	Speed Limit 1	Speed 1	0Hz – 255Hz
	Inching Speed	InchSpd	0Hz – 25Hz
1.7	Speed Limit 2	Speed 2	0Hz – 255Hz
	Inching Time	InchTime	0.1s – 10s
1.8	Speed Limit 3	Speed 3	0Hz – 255Hz
1.9	Direction Regen. Braking	DBrake	0% Hz – 100% Hz
1.10	Neutral Regen. Braking	NBrake	0% Hz – 100% Hz
1.11	Footbrake Regen Braking	FBrake	0% Hz – 100% Hz
1.12	Direction Braking Ramp	DBrkRamp	0.1s – 10.0s
1.13	Neutral Braking Ramp	NBrkRamp	0.1s – 10.0s
1.14	Footbrake Ramp	FbrkRamp	0.1s – 10.0s
1.15	Neutral Braking End Delay	NBrkEnd	0.1s – 10.0s
1.16	Sweep Speed	SweepSpd	0Hz – 5Hz
1.17	Maximum Current	MaxCurr	10A rms – Unit max.
1.18	Battery Voltage	BattV	24V – Unit max.
1.19	Power Steering Delay	PStrDly	0s – 50s
1.20	Electric Brake Delay	EBrkDly	0s – 50s
1.21	Accelerator 0% Voltage	AccMin	0V – 5V
1.22	Accelerator 100% Voltage	AccMax	0V – 5V
1.23	Footbrake 0% Voltage	AuxMin	0V – 5V
1.24	Footbrake 100% Voltage	AuxMax	0V – 5V
1.25	Steer Pot. Min.	StrMin	0V – 5V
1.26	Steer Pot. Mid.	StrMid	0V – 5V
1.27	Steer Pot. Max.	StrMax	0V – 5V
1.28	Forward Threshold	FwdTH	0V – 5V
1.29	Reverse Threshold	RevTH	0V – 5V
1.30	Max. Vehicle Speed	VmaxSpd	0 kph – 100 kph
1.31	BDI Reset Level	BDIreset	18V – 125% Bat. V
1.32	BDI Empty Level	BDIempty	12V – 125% Bat. V
1.33	BDI Warning Level	BDIwarn	0% – 99%
1.34	BDI Cut-out Level	BDIcut	0% – 99%
1.35	BDI Speed Limit	BDIspeed	0Hz – 255Hz
1.36	Dual Motor Cutback	DMcut	0% – 100%
1.37	Dual Motor Angle 1	DMang1	0% – 100%
1.38	Dual Motor Angle 2	DMang2	0% – 100%
1.39	Dual Motor Angle 3	Dmang3	0% – 100%
1.40	Dual Motor Speed 1	DMspd1	0Hz – 255Hz
1.41	Dual Motor Speed 2	DMspd2	0Hz – 255Hz
1.42	Dual Motor Speed 3	DMspd3	0Hz – 255Hz
1.43	Standby Delay	StdByDly	0 min (off) – 10 min

## I.1 Acceleration – (Accel)

This sets the time taken to accelerate from zero torque demand to maximum torque demand in Torque Control mode, or zero speed to maximum speed in Speed Control mode.

The maximum torque demand is set from the motor set-up table.

The maximum speed demand is set by 1.4 Maximum Forward Speed and 1.5 Maximum Reverse Speed.

Increasing the value results in a slower vehicle acceleration, while decreasing the value results in a faster vehicle acceleration.

The adjustable range is 0.1s to 10.0s in 0.1s steps.

## I.2 Deceleration – (Decel)

This sets the time taken to decelerate from maximum torque demand to zero torque demand in Torque Control mode, or maximum speed to zero speed in Speed Control mode.

Increasing the value results in a slower vehicle deceleration, while decreasing the value results in a faster vehicle deceleration.

The adjustable range is 0.1s to 10.0s in 0.1s steps.

## I.3 Creep Speed – (Creep)

This effectively sets the initial speed that the vehicle will adopt on entering drive.

Increasing the value will help minimise any delay from selecting drive to creeping the vehicle. The value relates to the frequency output of the controller, i.e. the motor's stator speed.

The adjustable range is 0Hz to 63.0Hz in 0.0625Hz steps.

## I.4 Maximum Forward Speed – (SpdMaxF)

This sets the maximum forward speed of the vehicle. The programmed value relates to the frequency output of the controller, i.e. the motor's stator speed.

The adjustable range is 0Hz to 255Hz in 1.0Hz steps.



**Maximum Forward Speed must not be set to a higher value than the parameter 4.8 Motor Speed Maximum, in the Motor Set-up menu. The 4.8 Motor Speed Maximum setting should always be programmed at least 10% higher than this setting.**

## I.5 Maximum Reverse Speed – (SpdMaxR)

This sets the maximum reverse speed of the vehicle. The programmed value relates to the frequency output of the controller, i.e. the motor's stator speed.

The adjustable range is 0Hz to 255Hz in 1.0Hz steps.



**Maximum Reverse Speed must not be set to a higher value than the parameter 4.8 Motor Speed Maximum, in the Motor Set-up menu. The 4.8 Motor Speed Maximum setting should always be programmed at least 10% higher than this setting.**

## I.6 Speed Limit I / Inching Speed – (Speed I/InchSpd)

The function of this parameter is dependent on the setting of, 3.5 Connector A Pin 5 and 6, in the Controller Set-up menu. That parameter sets whether pins 5 and 6 are used as speed limiting inputs or as inching control inputs.

If set to 0, then Speed Limit 1 sets the maximum speed of the vehicle when a switch connected to pin 5 on Connector A is open. The speed limit is not applied when the switch is closed or a lower speed limit is in operation.

The adjustable range is between 0Hz and 255Hz in 1.0Hz steps. The programmed value relates to the frequency output of the controller, i.e. the motor's stator speed.

If set to 1, then Inching Speed sets the speed of the vehicle (in both directions), that will be active when a switch connected to pin 5 or pin 6 of Connector A is closed. The vehicle will not inch when the switch is open.

The adjustable range is 0Hz to 255Hz in 1.0Hz steps. The programmed value relates to the frequency output of the controller, i.e. the motor's stator speed.

### **I.7 Speed Limit 2 / Inching Time – (Speed 2/InchTime)**

The function of this parameter is dependent on the setting of, 3.5 Connector A Pin 5 and 6, in the Controller Set-up menu. That parameter sets whether pins 5 and 6 are used as speed limiting inputs or as inching control inputs.

If set to 0, then Speed Limit 2 sets the maximum speed of the vehicle when a switch connected to pin 6 on Connector A is open. The speed limit is not applied when the switch is closed or a lower speed limit is in operation.

The adjustable range is between 0Hz and 255Hz in 1.0Hz steps. The programmed value relates to the frequency output of the controller, i.e. the motor's stator speed.

If set to 1, then Inching Time sets the period (in both directions), the vehicle will be moving for, when a switch connected to pin 5 or pin 6 of Connector A is closed. The vehicle will not inch when the switch is open.

The adjustable range is 0.1s to 10s in 0.1s steps.



**For ease of adjustment, this parameter should be set to 0Hz before programming 3.5 Connector A Pin 5 and 6 to 'Inching'.**

### **I.8 Speed Limit 3 – (Speed 3)**

The function of this parameter is dependent on the setting of, 3.6 Connector A Pin 7, in the Controller Set-up menu.

If set to 0, then Speed Limit 3 sets the maximum speed of the vehicle when a switch connected to Pin 7 on Connector A is open. The speed limit is not applied when the switch is closed or a lower speed limit is in operation.

If set to 1, then Speed Limit 3 sets the maximum speed of the vehicle when a switch connected to Pin 7 on Connector A is closed. The speed limit is not applied when the switch is open or a lower speed limit is in operation. Please note, that even if this parameter is set to 0Hz, the controller will continue to pulse whilst the Foot Switch is closed. This is designed to avoid rollback on gradients.

The adjustable range is 0Hz to 255Hz in 1.0Hz steps. The programmed value relates to the frequency output of the controller, i.e. the motor's stator speed.

### **I.9 Direction Regen. Braking – (DBrake)**

This sets the strength of the braking upon a direction change. The setting is a percentage of the Braking Direction Slip parameters, 4.22 & 4.23 and the Braking Slip parameters 4.24 & 4.25, in the Motor Set-up menu.

The adjustable range is 0% to 100% in 1.0% steps.

This parameter has no effect in Speed Control mode.

### **I.10 Neutral Regen. Braking – (NBrake)**

This sets the strength of the braking when the vehicle is in neutral, i.e. no drive signal in either direction. The setting is a percentage of the Braking Slip parameters, 4.24 & 4.25 and the Braking Neutral Slip parameters 4.28 & 4.29 in the Motor Set-up menu.

The adjustable range is 0% to 100% in 1.0% steps.

This parameter has no effect in Speed Control mode.

### I.11 Footbrake Regen. Braking – (FBrake)

This sets the strength of the braking when the brake pedal is fully operated, i.e. the voltage from the footbrake potentiometer is equal to the setting of the parameter, 1.24 Footbrake 100% Voltage. The setting is a percentage of the maximum permissible braking slip, as set by the Braking Slip parameters, 4.24 & 4.25 and the Braking Neutral Slip parameters 4.28 & 4.29 for the actual speed of the vehicle.

The adjustable range is 0% to 100% in 1.0% steps.

This parameter has no effect in Speed Control mode.

### I.12 Direction Braking Ramp – (DBrkRamp)

In Torque Control mode this sets the time taken to ramp from drive slip demand to full braking slip demand, as set by the parameter, 1.9 Direction Regen Braking, upon a change of direction. Increasing the value gives a smoother but longer transition from drive to braking.

In Speed Control mode this sets the time taken to ramp down the speed in the current direction to zero, upon a change of direction. After passing through zero speed, the normal acceleration time as described in 1.1 Acceleration, applies. Increasing the value gives a smoother but longer transition to zero speed.

The adjustable range is 0.1s to 10s in 0.1s steps.



**In Torque Control mode this parameter is normally set to a much lower value than when in Speed Control mode. Care must be taken when changing between Torque and Speed Control modes to ensure that this setting is adjusted correctly.**

### I.13 Neutral Braking Ramp – (NBrkRamp)

In Torque Control mode this sets the time taken to ramp from drive slip demand to full braking slip demand, as set by the parameter, 1.10 Neutral Regen. Braking, when the vehicle enters neutral, i.e. no drive signal in either direction. Increasing the value gives a smoother but longer transition from drive to braking.

In Speed Control mode this sets the time taken to ramp down the speed to zero, when the vehicle enters neutral, i.e. no drive signal in either direction. Increasing the value gives a smoother but longer transition to zero speed.

The adjustable range is 0.1s to 10s in 0.1s steps.



**In Torque Control mode this parameter is normally set to a much lower value than when in Speed Control mode. Care must be taken when changing between Torque and Speed Control modes to ensure that this setting is adjusted correctly.**

### I.14 Footbrake Ramp – (FBrkRamp)

In Torque Control mode this sets the time taken to ramp from drive slip to full braking slip demand, as set by the parameter, 1.11 Footbrake Regen. Braking, when the brake pedal is operated. Increasing the value gives a smoother but longer transition from drive to braking.

In Speed Control mode this sets the time taken to ramp down the speed to zero, when the footbrake pedal is operated. Increasing the value gives a smoother but longer transition to zero speed.

The adjustable range is 0.1s to 10s in 0.1s steps.



**In Torque Control mode this parameter is normally set to a much lower value than when in Speed Control mode. Care must be taken when changing between Torque and Speed Control modes to ensure that this setting is adjusted correctly.**

### I.15 Neutral Braking End Delay – (NBrkEnd)

This setting is normally associated with a Walkie type vehicle fitted with an electromechanical brake connected to pin 13 on Connector A. This setting allows a time to hold the vehicle at zero speed, i.e. hill hold, when the Neutral Braking Ramp time, 1.13 or Footbrake Ramp time, 1.14, have passed. It is usually used in conjunction with the parameter 1.20 Electric Brake Delay to operate the electromechanical brake.

The adjustable range is 0.1s to 10.0s in 0.1s steps.

### I.16 Sweep Speed – (SweepSpd)

This sets the maximum speed at which an instant direction change is possible. The purpose of the parameter is to minimise any delays as the vehicle is 'sweeping' through zero speed during a direction changeover.

The adjustable range is 0Hz to 5.0Hz in steps of 0.0625Hz. The programmed value relates to the frequency output of the controller, i.e. the motor's stator speed.

### I.17 Maximum Current – (MaxCurr)

This sets the maximum current limit during driving and braking.

The adjustable range is 10Arms to the maximum rating of the controller in 10Arms steps.

### I.18 Battery Voltage – (BattV)

This should be set to the nominal battery voltage of the system.

Whenever the battery voltage is equal to or less than this value, the BDI on the Sigmagauge will start to decrease.

The adjustable range is 24V to the maximum rating of the controller in 2V steps.

### I.19 Power Steering Delay – (PStrDly)

This sets the period that the Power Steer Contactor input, pin 14 on Connector A, will remain active after the trigger source has been removed. The trigger source is as set by the parameter, 3.7 Power Steering Trigger, in the Controller Set-up menu.

The adjustable range is 0s to 50s in 0.1s steps.

### I.20 Electric Brake Delay – (EBrkDly)

This setting is normally associated with a Walkie type vehicle fitted with an electromechanical brake connected to pin 13 on Connector A. The value, e.g. 0.2s, sets the delay between detecting the vehicle is at standstill and the electric brake being applied.

There is also a fixed period of 0.1s that sets the delay from when pulsing starts, to the electric brake being released. This helps prevent roll back on a Walkie truck when starting drive on a gradient.

The adjustable range is 0s to 50s in 0.1s steps.

### I.21 Accelerator 0% Voltage – (AccMin)

This sets the voltage on the Accelerator input that will correspond to zero speed\*.

The adjustable range is 0V to 5V in 0.1V steps.

The Accelerator input can be configured via the parameter, 3.14 Analogue Inputs Set-up, in the Controller Set-up menu.

### I.22 Accelerator 100% Voltage – (AccMax)

This sets the voltage on the Accelerator input that will correspond to maximum speed\*.

The adjustable range is 0V to 5V in 0.1V steps.

The Accelerator input can be configured via the parameter, 3.14 Analogue Inputs Set-up, in the Controller Set-up menu.



**\*If 3.14 Analogue Inputs Set-up in the Controller Set-up menu is set to '2', the active range of the Throttle input is defined by the programmable parameters, I.21 Accelerator 0% Voltage and I.22 Accelerator 100% Voltage. The former parameter sets the voltage that relates to 100% reverse drive demand from the Throttle, while the latter parameter sets the voltage that relates to 100% forward drive demand from the Throttle.**

### **I.23 Footbrake 0% Voltage – (AuxMin)**

This sets the voltage on the Footbrake input that will correspond to zero braking force.

The adjustable range is 0V to 5V in 0.1V steps.

The Footbrake input can be configured via the parameter, 3.14 Analogue Inputs Set-up, in the Controller Set-up menu.

### **I.24 Footbrake 100% Voltage – (AuxMax)**

This sets the voltage on the Footbrake input that will correspond to the braking force as set by the parameter, 1.11 Footbrake Regen Braking.

The adjustable range is 0V to 5V in 0.1V steps.

The Footbrake input can be configured via the parameter, 3.14 Analogue Inputs Set-up, in the Controller Set-up menu.

### **I.25 Steer Pot. Min. – (StrMin)**

The operation of this parameter is dependent on the setting of 3.15 Single / Dual Motor Select, in the Controller Set-up menu. If that parameter is set to 0 (motor temperature), then this setting has no effect.

If it is set to 1 or 2 (dual motor left or dual motor right), then this parameter sets the voltage on the Steering Pot input, pin 4 of Connector C, which will correspond to the minimum steering angle. By convention, the minimum steering angle relates to the full left hand lock of the vehicle.

The adjustable range is 0V to 5V in 0.1V steps.

### **I.26 Steer Pot. Mid. – (StrMid)**

The operation of this parameter is dependent on the setting of 3.15 Single / Dual Motor Select, in the Controller Set-up menu. If that parameter is set to 0 (motor temperature), then this setting has no effect.

If it is set to 1 or 2 (dual motor left or dual motor right), then this parameter sets the voltage on the Steering Pot input, pin 4 of Connector C, which will correspond to a 0° steering angle, i.e. the vehicle performs no steering operation.

The adjustable range is 0V to 5V in 0.1V steps.

### **I.27 Steer Pot. Max. – (StrMax)**

The operation of this parameter is dependent on the setting of 3.15 Single / Dual Motor Select, in the Controller Set-up menu. If that parameter is set to 0 (motor temperature), then this setting has no effect.

If it is set to 1 or 2 (dual motor left or dual motor right), then this parameter sets the voltage on the Steering Pot Input, pin 4 of Connector C, which will correspond to the maximum steering angle. By convention, the maximum steering angle relates to the full right hand lock of the vehicle.

The adjustable range is 0V to 5V in 0.1V steps.

### **I.28 Forward Threshold – (FwdTH)**

The operation of this parameter is dependant on the setting of 3.14 Analogue Inputs Set-up, in the Controller Set-up Menu. If that parameter is set to 2 (Wig-wag), then this value sets the voltage on pin 9 of Connector A from which forward drive commences.



Together with 1.29 Reverse Threshold, this parameter forms a 'deadband' in which the wig-wag assumes a neutral position. The adjustable range is 0V to 5V in 0.1V steps.

### **1.29 Reverse Threshold – (RevTH)**

The operation of this parameter is dependant on the setting of 3.14 Analogue Inputs Set-up, in the Controller Set-up Menu. If that parameter is set to 2 (Wig-wag), then this value sets the voltage on pin 9 of Connector A from which reverse drive commences.

Together with 1.28 Forward Threshold, this parameter forms a 'deadband' in which the wig-wag assumes a neutral position. The adjustable range is 0V to 5V in 0.1V steps.

### **1.30 Max. Vehicle Speed – (VmaxSpd)**

This sets the maximum value that is indicated on the Sigmagauge LCD when the vehicle is driving at maximum speed. To calibrate this value to the output from the encoder, set the parameter, 4.2 Motor to Vehicle Speed Ratio, in the Motor Set-up menu.

The adjustable range is 0kph to 100kph in 1kph steps.

Setting the parameter to 0kph means that there will be no indication of speed shown on the Sigmagauge LCD.

### **1.31 BDI Reset Level – (BDIreset)**

This sets the voltage at which the BDI will reset to show a 100% charged battery on the Sigmagauge. This setting only has an effect at power-up.

The adjustable range is 18V to 125% of the nominal operating voltage of the controller in 0.1V steps.

### **1.32 BDI Empty Level – (BDIempty)**

This sets the 0% charge level for the BDI. Whenever the battery voltage is equal to or less than 1.18 Battery Voltage, the BDI on the Sigmagauge will start to decrease.

The adjustable range is 12V to 125% of the nominal operating voltage of the controller in 0.1V steps.

### **1.33 BDI Warning Level – (BDIwarn)**

This sets the level of battery charge at which the BDI warning icon on the Sigmagauge will start to flash. The value is set as a percentage of battery charge. 100% battery charge corresponds to the voltage set by the parameter, 1.31 BDI Reset Level and 0% battery charge corresponds to the voltage set by the parameter, 1.32 BDI Empty Level.

The adjustable range is 0% to 99% in 1% steps.

### **1.34 BDI Cut-out Level – (BDIcut)**

This sets the level of battery charge at which the speed of the vehicle will be limited to a value set by the parameter, 1.35 BDI Speed Limit. The cut-out value is set as a percentage of battery charge. 100% battery charge corresponds to the voltage set by the parameter, 1.31 BDI Reset Level and 0% battery charge corresponds to a level set by the parameter, 1.32 BDI Empty Level.

The adjustable range is 0% to 99% in 1% steps.

### **1.35 BDI Speed Limit – (BDIspeed)**

This sets the maximum speed of the vehicle if the BDI level is below the value set by the parameter, 1.34 BDI Cut Out Level.

The adjustable range is 0Hz to 255Hz in 1Hz steps.

**I.36 Dual Motor Cutback – (DMcut)****I.37 Dual Motor Angle 1 – (DMang1)****I.38 Dual Motor Angle 2 – (DMang2)****I.39 Dual Motor Angle 3 – (Dmang3)****I.40 Dual Motor Speed 1 – (DMspd1)****I.41 Dual Motor Speed 2 – (DMspd2)****I.42 Dual Motor Speed 3 – (DMspd3)**

For these functions to be active, the parameter, 3.2 Control Mode, must be set to 1 (Torque) and 3.15 Single / Dual Motor Select, must be set to 1 or 2.

The values for parameters 1.36 to 1.39 are expressed as percentages, where:

100% = a voltage corresponding to the parameter, 1.27 Steer Pot. Max. (normally full right hand lock).

-100% = a voltage corresponding to the parameter, 1.25 Steer Pot. Min. (normally full left hand lock).

0% = a voltage corresponding to the parameter, 1.26 Steer Pot. Mid. (no steer).

Dual Motor Cutback sets the point at which the inner motor starts to reduce speed in response to the position of the steering potentiometer. For example, if a value of 10% is chosen, then the speed reduction will commence if the steering potentiometer is outside of a central deadband of +/- 10%.

In the central deadband, the inner motor speed is equal to the outer motor speed and corresponds to the driving speed of the vehicle.

The relationship between parameters 1.36 to 1.42 is explained below for both the inner and outer motors.

**Inner motor** – When the steering pot is beyond the 1.36 Dual Motor Cutback setting towards the 1.37 Dual Motor Angle 1 setting, the motor starts to reduce speed towards the 1.40 Dual Motor Speed 1 setting, while it also reduces the torque towards zero.

When the steering pot is between 1.37 Dual Motor Angle 1 and 1.38 Dual Motor Angle 2, the torque of the inner motor is zero, meaning it is able to freewheel.

Steering beyond the 1.38 Dual Motor Angle 2 towards the 1.39 Dual Motor Angle 3, causes the inner motor to reverse its direction, torque is increased towards half the demanded torque and the speed of the inner motor starts at 1.41 Dual Motor Speed 2 and is increased towards half the value of the 1.42 Dual Motor Speed 3 setting.

When steering beyond the 1.39 Dual Motor Angle 3 setting towards 100% full steering, the torque of the inner motor is maintained at half the demanded torque and the speed is set to half the value of the 1.42 Dual Motor Speed 3 setting.

**Outer motor** – When the steering pot is beyond the 1.36 Dual Motor Cutback setting and towards the 1.38 Dual Motor Angle 2 setting, the speed of the outer motor is reduced towards the 1.42 Dual Motor Speed 3 setting.

When steering between 1.38 Dual Motor Angle 2 and 1.39 Dual Motor Angle 3, the speed of the outer motor is reduced from the 1.42 Dual Motor Speed 3 setting towards half of the 1.42 Dual Motor Speed 3 setting.

Steering beyond the 1.39 Dual Motor Angle 3 setting maintains the speed of the outer motor at half the 1.42 Dual Motor Speed 3 setting.

The torque of the outer motor is maintained at the demanded torque.

The reason why both inner and outer motors are maintaining a speed half that of the 1.42 Dual Motor Speed 3 setting is because the outer motor runs in one direction while the inner motor runs in the opposite direction. This produces a total speed twice that of one motor. Therefore, the total speed beyond 1.39 Dual Motor Angle 3 is exactly the 1.42 Dual Motor Speed 3 setting.

The torque of the inner motor is halved to prevent a sudden increase in speed when steering rapidly beyond the 1.38 Dual Motor Angle 2 setting.

The following graph shows an example of how these settings work with each other.

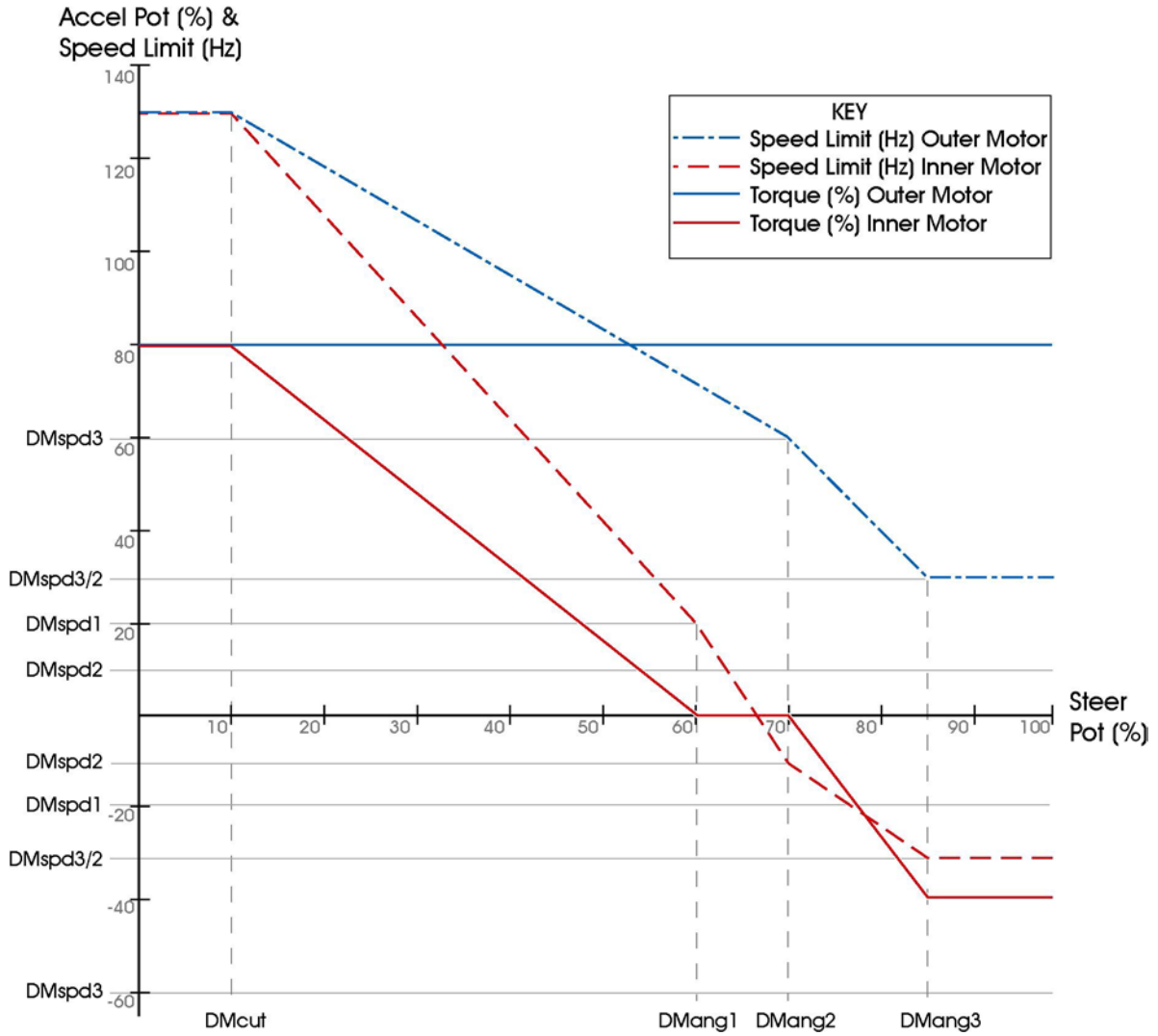

### I.43 Standby Delay – (StdByDly)

This sets a period of time after which the Line Contactor will be de-energised if there is no drive activity and the seat or tiller switch is open. When the seat or tiller switch is closed, the controller powers up, performs all necessary hardware and software checks and closes the line contactor.

The adjustable range is 0 min to 10 min in 0.5 min steps.





## CHAPTER 3 – DIAGNOSTICS



## I Error Detection

If the controller detects an error, it can be displayed in up to four different ways.

Firstly, the red LED on the controller itself will flash. The number of flashes in the sequence will reflect the error code.

The error code can also be read by the Programmer. It will be displayed as a number (preceded by 'F'), on the right-hand side of the Controller Type screen as shown below.

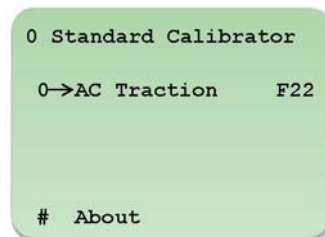





















The Programmer's Status menu also allows both the current and previous error codes to be viewed. See section, Status, for more details.









Lastly, the Sigmagauge display can signal an error, using specific icons. Refer to the Sigmagauge chapter for further details.

## 2 Error Codes

Once the error type has been noted, refer to the following table to identify the cause. If the error persists after taking the suggested action, contact your Service Agent.



Code / LED Flashes	Sigmatagauge Icon	Cause / Action
<b>Warning Error</b>		
0 / On		Controller is functioning.
1		Handbrake switch closed. Release Handbrake.
2		Battery voltage 'becoming' too low. Charge battery or check its condition and connections.
3		Not used.
4		Battery voltage 'becoming' too high. Reduce braking levels or vehicle speed.
5		Thermal foldback. Allow motor to cool, operate vehicle within specification.
6		Controller over-temperature. Allow controller to cool and check drive train.
7		Out-of-Range programming. Check all parameters are within permitted limits.
8		Default settings restored after re-flash. Cycle power.
<b>Main Error – Recycle to Neutral</b>		
9		Internal memory error. Contact Service Agent.
10		Direction selection error - both Fwd and Rev selected. Check direction switch operation and connections.
11		Seat or Tiller switch not closed. Check switch operation and connections.
12		Sequence error - the Footswitch or Direction switch is operated at power-up. Check switch operation and connections.
13		Accelerator deflected at power-up. Check Accelerator operation and connections.
14		Ride-on - forbidden input selected (Fwd, Rev, FS, Seat, Handbrake), when inching the vehicle. Walkie - drive is attempted without releasing the belly switch after time-out period has passed.
15		Internal 12 V supply too low. Check peripherals and battery.
16		Not used.
17		Battery voltage too low. Charge battery or check its condition and connections.
18		High-side MOSFET error in neutral or while pulsing. Check motor insulation and line contactor. If error persists, contact Service Agent.
19		Low-side MOSFET error while pulsing. Check motor insulation. If error persists, contact Service Agent.
<b>Hard Error – Recycle Key-switch</b>		
20		Motor over-current. Check programming of motor parameters.
21		Contactor coil error. Check contactor coil(s) and connections.
22		Battery voltage too high. Reduce braking levels or speed.













23		Low-side MOSFET error in neutral. Check motor insulation and line contactor. If error persists, contact Service Agent.
24		Controller error or line contactor coil error. Check line contactor coil. If error persists, contact Service Agent.
25		Contact error. Check coil(s) & contacts.
26		Controller error. Contact Service Agent.
27		Low-side MOSFET error before line contactor has closed. Check motor insulation and line contactor. If error persists, contact Service Agent.
28		Wig-Wag wire off detected. Check pot. wiring on Connector A pins 8, 9 and 16.
29		CAN error. A CAN node is not responding. Check all nodes and their connections.
30		Over-speed or encoder error. Check encoder programming value 4.3 Number of Teeth and ensure that 4.8 Motor Speed Maximum is higher than 1.4 Maximum Forward Speed and 1.5 Maximum Reverse Speed.

### 3 Status

The Programmer's Status menu shows a live-readout of parameter values. This is extremely useful when fine-tuning the system or carrying out diagnostic work. The table below gives details of the parameters that may be viewed.

Some of the menu items have additional functions that can be accessed via the  and  buttons. The options that display recorded minimum and maximum values relate to the lifetime of the controller.

The functions, 2.10 Accelerator Slip Demand, 2.11 Damped Slip Demand and 2.12 Motor Voltage also display further status information. This information is displayed in place of the Hz units on the screen. See Further Status Information for more details.

Ref.	Parameter	Programmer Text	Steps/Units	Notes
2.1	Drive Hours Counter	Drive	0.1Hrs	
2.2	Error Log  Time of Error	Fault		Last recorded error code. Measured in Drive Hours.
2.3	Battery Discharge Indicator	BDI	1%	
2.4	Vehicle Speed	Vehicle	1Kph	
2.5	Controller Temperature  Minimum Temperature  Maximum Temperature	CtrlTmp	1°C	
2.6	Steering Angle Motor Temperature  Minimum Temperature  Maximum Temperature	StrPot MotTemp	1% 1°C	Units displayed as % or °C
2.7	Battery Voltage  Maximum Voltage	BatVolts	0.1V	
2.8	Capacitor (Bridge) Voltage  Maximum Voltage	Cap	0.1V	
2.9	Accelerator  Auxiliary Input	Accel	1%	Actual input from Accelerator. Actual input from Auxiliary input.
2.10	Accelerator Slip Demand *	DemandT	1Hz	Accelerator input expressed as Slip or speed.
2.11	Damped Slip Demand *	DemandR	1Hz	After ramps and limits
2.12	Motor Voltage*  V displayed in bits 0 – 242.  V as % of max battery V	MotorV	0.1Vrms	+ = Motor V allowed - = Motor V limited by battery V
2.13	Motor Current**	Motor	10Arms	
2.14	Motor (Stator) Frequency	Motor	1Hz	+ = Forward, - = Reverse
2.15	Rotor Speed  Rotor speed in rpm	Rotor	1Hz 1rpm	+ = Forward, - = Reverse
2.16	Slip	Slip	1Hz	+ = Drive Slip, - = Brake Slip
2.17	Maximum Slip	Slip Max	1Hz	Maximum permitted Slip for the current Stator Frequency. + = Drive Slip, - = Brake Slip
2.18	Min V for this speed	VrmsMin	0.1V	Minimum permitted voltage for the current Stator Frequency.
2.19	Actual V now	VrmsNow	0.1V	Voltage at current Stator Frequency.
2.20	Max V for this speed	VrmsMax	0.1V	Maximum permitted voltage for the current Stator Frequency.
2.21	PGDT Use Only			
2.22	PGDT Use Only			
2.23	PGDT Use Only			
2.24	PGDT Use Only			

\* See section, Further Status Information.

\*\* The use of a current clamp or similar measuring device is recommended at lower levels.

## 4 Further Status Information

The status information, 2.10 Accelerator Slip Demand, also relays some operational status data about the controller. This is in the form of a two-letter abbreviation that replaces the “Hz” on the Programmer’s screen. These abbreviations are listed below.

N:	Neutral, i.e. no drive demand and controller is not pulsing.
FD:	Forward Drive, i.e. controller is applying forward drive to the motor.
FL:	Forward Drive Left controller in dual motor configuration.
FR:	Forward Drive Right controller in dual motor configuration.
RD:	Reverse Drive, i.e. controller is applying reverse drive to the motor.
RL:	Reverse Drive Left controller in dual motor configuration.
RR:	Reverse Drive Right controller in dual motor configuration.
DB:	Direction Braking, i.e. the controller is braking as the result of a direction change.
NB:	Neutral Braking, i.e. the controller is braking as a result of a neutral drive demand.
FB:	Footbraking, i.e. the controller is braking as a result of the Footbrake being operated.
HH:	Hill hold i.e. the controller is holding the vehicle stationary on a hill.
HF:	Restrained hill hold in the forward direction, i.e. the controller is limiting the roll-away speed of the vehicle.
HR:	Restrained hill hold in the reverse direction, i.e. the controller is limiting the roll-away speed of the vehicle.
SB:	Standby, i.e. the controller is in a standby condition.

The status information, 2.11 Damped Slip Demand, also relays some status data about the controller. Again, this is in the form of a two-letter abbreviation that replaces the “Hz” on the Programmer’s screen. These abbreviations are listed below.

SM:	Maximum Speed, i.e. maximum speed is available, no limits or interlocks active.
S1:	Speed Limit 1 is active.
S2:	Speed Limit 2 is active.
S3:	Speed Limit 3 is active.
S4:	Not used.
S5:	Not used.
S6:	Not used.
SI:	Inching Speed is being applied.
SB:	BDI Speed Limit is being applied.
SD:	Dual Motor Speed Limit is being applied.
CL:	Current Limit, i.e. the controller is in drive current limit mode.
BL:	Brake Current Limit, i.e. the controller is in braking current limit mode.
CT:	Controller Temperature, i.e. the controller has reduced its output due to a high heatsink temperature.
MT:	Motor Temperature, i.e. the controller has reduced its output due to a high motor temperature.

The status information 2.12 Motor Voltage, also relays the current error code. This is in the form of an abbreviation as shown below.

Fxx:	Error Code, where ‘xx’ denotes the specific error.
------	--

## 5 Test

The Programmer's Test menu allows a live-readout of the controller's inputs and outputs. This is extremely useful when carrying out diagnostic work. The table below gives details of the inputs and outputs that may be viewed.

Ref.	Function	Input/Output	Display Format
5.1	Forward Switch	Conn. A pin 1	0/1 0 = Open, 1 = Closed
5.2	Reverse Switch	Conn. A pin 2	0/1 0 = Open, 1 = Closed
5.3	Footswitch / Belly Button	Conn. A pin 3	0/1 0 = Open, 1 = Closed
5.4	Seat Switch / Tiller Switch	Conn. A pin 4	0/1 0 = Open, 1 = Closed
5.5	Speed Limit 1 / Inch Forward	Conn. A pin 5	0/1 0 = Open, 1 = Closed
5.6	Speed Limit 2 / Inch Reverse	Conn. A pin 6	0/1 0 = Open, 1 = Closed
5.7	Speed Limit 3 / Handbrake	Conn. A pin 7	0/1 0 = Open, 1 = Closed
5.8	Footbrake Switch	Conn. A pin 8/9	0/1 0 = Open, 1 = Closed
5.9	Accelerator (%)	Conn. A pin 8/9	0% to 100%
5.10	Accelerator (V)	Conn. A pin 8/9	0V to 5.1V
5.11	Footbrake (%)	Conn. A pin 8/9	0% to 100%
5.12	Footbrake (V)	Conn. A pin 8/9	0V to 5.1V
5.13	Steering Pot. (%)	Conn. C pin 4	0% to 100%
5.14	Thermistor / Steering Pot. (V)	Conn. C pin 4	0V to 5.1V
5.15	Line Contactor	Conn. A pin 12	0/1 0 = 0V, 1 = Vbatt.
5.16	Electric Brake Contactor	Conn. A pin 13	0/1 0 = 0V, 1 = Vbatt.
5.17	Power Steer Contactor	Conn. A pin 14	0/1 0 = 0V, 1 = Vbatt.
5.18	Encoder (Speed)	Conn. C pin 1	0/1 0 = 0V, 1 = 5V
5.19	Encoder (Direction)	Conn. C pin 2	0/1 0 = 0V, 1 = 5V
5.20	Remote LED	Conn. C pin 3	0/1 0 = Off, 1 = On
5.21	Red LED		0/1 0 = Off, 1 = On
5.22	Green LED		0/1 0 = Off, 1 = On
5.23	Not used		Reserved for Future Use
5.24	12V		0/1 0 = 12V Internal Rail Low, 1 = 12V OK



## CHAPTER 4 – CONTROLLER SET-UP



## I Controller Set-up

The Sigmadrive Programmer 'Controller Set-up' menu (3. Controller Set-up), contains the parameters shown in the table below. Each parameter has a unique reference number, 3.x, as shown in the left-hand column. The right-hand column shows the parameter name as it appears on the Programmer screen.

Ref.	Parameter	Programmer Text
3.1	Accelerator Characteristic	Lin/Curv
3.2	Control Mode (Traction)	Spd/Torq
3.3	Proportional Braking	Off/Bpro
3.4	Anti Roll-off (Restraint)	Off/Arol
3.5	Connector A Pin 5 and 6	Spd/Inch
3.6	Connector A Pin 7	Spd3/Hbk
3.7	Power Steering Trigger	PsF/FR/S
3.8	Truck Type Select	Ride/Wlk
3.9	Tiller Function	TillFunc
3.10	Display Error Indication	Of/M/M&W
3.11	Display Status Field	Of/D/V/K
3.12	Not Used	- n/a -
3.13	Motor Temperature Sensor Type	MTempTyp
3.14	Analogue Inputs Set-up	Accel 8/9
3.15	Single / Dual Motor Select	Si/DL/DR
3.16	Remote LED / Brake Light	RL/BL
3.17	CAN Node Number	CAN node
3.18	Shared Line Contactor	ShareLC
3.19	Last Sharing Node	LstNode

## I.1 Accelerator Characteristic – (Lin/Curv)

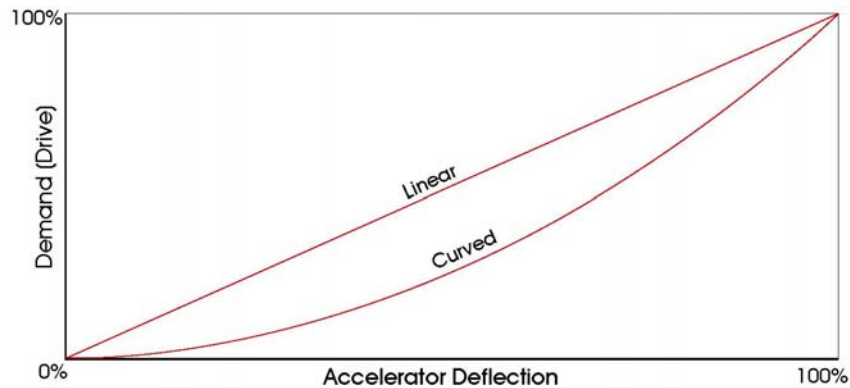

This sets the type of response for the Accelerator Input (pins 8 or 9 on Connector A). There are two options for AC Traction control, Linear and Curved.

The definition of each type is detailed below.

Linear: For input values of 0%, 50% and 100%, the output will be 0%, 50% and 100%.

Curved: For input values of 0%, 50% and 100%, the output will be 0%, 25% and 100%.

There are two programmable options – 0 and 1.

If set to 0, the controller will apply a linear accelerator input.

If set to 1, the controller will apply a curved accelerator input.

## I.2 Control Mode (Traction) – (Spd/Torq)

This sets whether the controller provides speed type or torque type control.

Speed control means that the Accelerator input is used to set a speed demand between zero and the programmed maximum speed for the direction of drive. Speed control results in a constant drive speed for a given demand (Accelerator deflection), regardless of load.

Torque control means that the Accelerator input is used to set a torque (slip) demand between zero and the programmed maximum torque (slip) for the current drive speed. Torque control has the feel of a car, i.e. as the load increases, the vehicle will slow and then more demand (Accelerator deflection), must be applied.

The programmable options are 0 and 1:

If set to 0, then the controller will apply speed control.

If set to 1, then the controller will apply torque control.

## I.3 Proportional Braking – (Off/Bpro)

This sets how the strength of the direction regenerative braking is controlled.

There are two programmable options – 0 and 1.

If set to 0 (Fixed), the braking strength is as set by the parameter, 1.9 Direction Regen. Braking, regardless of Accelerator potentiometer position.

If set to 1 (Proportional), the braking strength corresponds to the Accelerator potentiometer position. At the minimum Accelerator potentiometer position, the braking strength will be as set by the parameter, 1.10 Neutral Regen. Braking, while at the maximum Accelerator potentiometer position, the braking strength will be as set by the parameter, 1.9 Direction Regen. Braking. Between minimum and maximum, the braking strength is a value between the neutral and direction braking settings, proportional to the Accelerator potentiometer position.



#### I.4 Anti Roll-off (Hill Hold & Restraint) – (Off/Arol)

This sets whether there is a hill-hold and/or restraint function when the vehicle is at rest.

There are three programmable options – 0, 1 and 2.

If set to 0 (Coast), then there is no restraint function and the vehicle is free to coast.

If set to 1 (Hill Hold & Restraint), then the controller will limit the coasting speed of the vehicle. Following neutral braking, the vehicle will enter and remain in Hill Hold mode for a period set by the parameter, 4.39 Hill Hold Time. During this period, the vehicle will remain stationary. After this time has elapsed, the vehicle will enter Restraint mode at a speed set by the parameter 4.40 Hill Hold Speed. If the vehicle reaches level ground and the motor is no longer moving, or the handbrake is applied, Restraint is switched off in order to save battery power. If the motor begins to move again, without Accelerator demand being applied, then the controller will re-enter Restraint mode until the vehicle either comes to rest or the handbrake is applied.

If set to 2 (Restraint), then the controller will limit the coasting speed of the vehicle. Following neutral braking, the vehicle will enter Restraint mode, using DC current, for a period set by the parameter, 4.39 Hill Hold Time. After this time has elapsed, the vehicle will enter Restraint mode at a speed set by the parameter 4.40 Hill Hold Speed. The controller will continue to be restrained until the motor is no longer moving or the handbrake is applied, just as if set to '1'.

#### I.5 Connector A Pin 5 and 6 – (Spd/Inch)

This sets the function of the input pins 5 and 6 on Connector A.

There are two programmable options – 0 and 1.

If set to 0 (Speed Limit), then the inputs can be used to limit the speed of the vehicle via the parameters, 1.6 Speed Limit 1 and 1.7 Speed Limit 2.

If set to 1 (Inching), then the inputs can be used to "inch" the vehicle. In this case, the function of parameters 1.6 and 1.7 will become, 1.6 Inching Speed and 1.7 Inching Time.

Both pins are normally closed inputs.



**For ease of adjustment, the value of I.7 Speed Limit 2 / Inching Time should be set to 0Hz before programming this parameter.**

#### I.6 Connector A Pin 7 – (Spd3/Hbk)

This sets the function of input pin 7 on Connector A.

There are two programmable options – 0 and 1.

If set to 0 (Speed Limit 3), then the input can be used to limit the speed of the vehicle to a level set by the parameter, 1.8 Speed Limit 3. The limit will apply when a switch connected to pin 7 of Connector A is open.

If set to 1 (Handbrake), then the input can be used to limit the speed of the vehicle to a level set by the parameter, 1.8 Speed Limit 3. The limit will apply when a switch (normally the Handbrake switch), connected to pin 7 of Connector A is closed. When the switch is closed, the Sigmagauge will show a 'parked' icon.

#### I.7 Power Steering Trigger – (PsF/FR/S)

This sets the trigger source for the power steer contactor. When the vehicle has stopped driving, a timer sets a delay for the power steering to remain active. The length of the delay is set by the parameter, 1.19 Power Steering Delay.

There are four programmable options – 0, 1, 2 and 3.

If set to 0 (Footswitch), then the power steer contactor is driven at the instant the Footswitch (Connector A pin 3), is closed.

If set to 1 (Forward/Reverse), then the power steer contactor is driven at the instant either the Forward Switch (Connector A pin 1) or the Reverse Switch (Connector A pin 2), are closed.

If set to 2 (Seat), then the power steer contactor is driven at the instant the Seat Switch (Connector A pin 4), is closed.

If set to 3 (Footswitch & Motor Speed), then the power steer contactor is driven on the Footswitch as described above but also when the motor speed is greater than zero. This can be useful in combination with 3.4 Anti Roll-off.

### I.8 Truck Type Select (Ride/Wlk)

This sets the function of the input pins 3 and 4 on Connector A.

There are three programmable options – 0, 1 and 2.

If set to 0 (Ride-on), then pin 3 will be a Footswitch input and pin 4 will be a Seat Switch input.

If set to 1 (Walkie), then pin 3 will be a Belly Button input and pin 4 will be a Tiller Switch input.

If set to 2 (Walkie – allow drive with open tiller switch), the pin configuration is the same as if set to '1'. However, additional functionality allows the driver to operate the vehicle with the tiller switch open, provided pin 7 on Connector A is closed. This can assist drivers to manoeuvre in smaller areas, such as truck platforms.

### I.9 Tiller Function (TillFunc)

This sets the function of the tiller switch when 3.8 Truck Type Select is set to 1 or 2 (Walkie).

There are three programmable options – 0, 1 and 2.

If set to 0, the controller will apply neutral braking when the tiller switch is opened. Once zero speed has been reached the vehicle will be held for 1.15 Neutral Braking End Delay time until the electric brake has been applied.

If set to 1, the controller will apply neutral braking when the tiller switch is opened. This will be performed with a fixed 0.5 s 1.13 Neutral Braking Ramp time. As soon as the controller has reached zero speed, the electro-mechanical brake will be applied without any delays. Pulsing stops after the 1.15 Neutral Braking End Delay.

If set to 2, the electro-mechanical brake will be applied as soon as the tiller switch is opened. The controller will neutral brake with a fixed 0.5 s 1.13 Neutral Braking Ramp time and will stop pulsing after the 1.15 Neutral Brake End Delay.



**If 3.8 Truck Type Select is set to '2', the electro-mechanical brake will not be applied when Connector A, pin 7 is closed.**

### I.10 Display Error Indication – (Of/M/M&W)

This sets the type of errors that are displayed on the Sigmagauge, if fitted.

There are three programmable options – 0, 1 and 2.

If set to 0 (None), only 'Hard' errors will be displayed on the Sigmagauge.

If set to 1 (Main), both 'Hard' and 'Main' errors that prevent driving will be displayed on the Sigmagauge.

If set to 2 (Main and Warning), all errors – 'Hard', 'Main' and 'Warning' (which do not prevent driving), will be displayed on the Sigmagauge.

### I.11 Display Status Field – (Of/D/V/K)

This sets the type of information that will appear in the General Indication Field of the Sigmagauge, if fitted.

There are six programmable options – 0, 1, 2, 3, 4 and 5.

If set to 0 (None), then the General Indication Field will be blank.

If set to 1 (Accelerator), then the Accelerator deflection as a percentage will be displayed, from 0% to 100%.

If set to 2 (Motor), then the motor speed in units of 'rpm' will be displayed, from 0 to the value set in 4.8 Motor Speed Maximum.

If set to 3 (Speed), then the vehicle speed in units of 'kph' will be displayed, from 0 to the value set in 1.30 Max. Vehicle Speed. (If 1.30 is set to zero, then no speed will be displayed in the General Indication Field).

If set to 4 (Steering), then the vehicle's steering angle will be displayed using crosshairs.

If set to 5 (Motor Current), then the motor current in units of 'A' will be displayed, from 0 to the maximum rated current of the controller.

### I.I2 Not Used

Not used.

### I.I3 Motor Temperature Sensor Type – (MtempTyp)

This sets the type of motor temperature sensor that the controller will interface to via pin 4 of Connector C.

There are two programmable options – 0 and 1.

If set to 0, then this input can be connected to a Philips, KTY81-220 thermistor (PTC 2K @ 25°C) used with an external 2K2 pull-up resistor to +5V.

If set to 1, then this input can be connected to a Philips, KTY84 thermistor (PTC 1K @100°C), used with an external 2K2 pull-up resistor to +5V.

### I.I4 Analogue Inputs Set-up – (Accel 8/9)

This sets the function of input pins 8 and 9 on Connector A.

There are three programmable options – 0, 1 and 2.

If set to 0, then pin 8 will be the Accelerator input and pin 9 will be the Footbrake input.

If set to 1, then pin 8 will be the Footbrake input and pin 9 will be the Accelerator input.

If set to 2, then pin 9 will be a Wig-wag Throttle input and pin 8 is not used.

### I.I5 Single / Dual Motor Select – (Si/DL/DR)

This sets the function of the input associated with pin 4 on Connector C and whether a controller is the left or right hand unit in a dual motor system.

There are three programmable options – 0, 1 and 2.

If set to 0 (Motor Temperature), then the input can be used to reduce the controller's current output as the motor temperature rises. The relationship between controller output and motor temperature is set by the parameter 4.1 Motor Temperature Cutback.

If set to 1 (Dual Motor Left), then the input can be used to connect to the vehicle's Steering potentiometer, which will feed back the angle of the steered wheels. The controller will be assigned as the left hand unit.

If set to 2 (Dual Motor Right), then the input can be used to connect to the vehicle's Steering potentiometer, which will feed back the angle of the steered wheels. The controller will be assigned as the right hand unit.

When a Dual Motor selection is made, the speed and torque when steering, will change as described by the parameters 1.36 to 1.42 in the Adjustments chapter.



**Dual motor selection is only available in Torque Mode.**

### I.I6 Remote LED / Brake Light – (RL/BL)

This sets the function of the output associated with pin 3 on Connector C and whether the output is used as an external fault indicator or as a brake light.

If set to 0 (Remote LED) then the output may be used to drive an external fault indicator.

If set to 1 (Brake Light) then the output may be used to drive a brake light. The brake light will only be active during Footbraking.



**An external 'driver module' must be connected to operate either an LED or Brake Light.**

### I.17 CAN Node Number – (CAN node)

The sets the CAN node number for the controller.

There are sixteen programmable options – 0 to 15.

If set to 0 (Master), then this controller is responsible for the following:

- General Indication Field as described in 3.11 Display Status Field.
- BDI information for the Sigmagaugue.
- BDI information to all other controllers (slaves), attached to the CANbus.
- Checking the state of all slaves when a shared line contactor is used.
- Controlling the line contactor when a shared line contactor is used.
- Device, fault icon and pulsing information to the Sigmagaugue.

If set from 1 to 15, the controller will be a slave.

In multiple controller systems, it is essential that all CAN nodes have a unique number. A slave uses the BDI from the master so disregards it's own BDI and associated settings 1.31, 1.32 & 1.33. However, the BDI cut-out levels, 1.34 and BDI speed, 1.35, still apply. In this way the BDI is equal to all devices on the CANbus, while each controller can set up it's own cut-out and speed levels. All slaves also send out their device, fault code icon and pulsing information to the Sigmagaugue.

In a non-CANbus system, the controller(s) should have this parameter set to 0. This is particularly important if the BDI is used. As detailed above, the BDI will not work when set up as a slave controller.



**To set the CAN node number in a controller, it must be disconnected from the CANbus.**

### I.18 Shared Line Contactor – (ShareLC)

This sets whether the controller is able to share a line contactor with another controller(s) in a CANbus connected network.

The Master Controller regularly checks all slaves that share the line contactor, in addition to controlling the line contactor itself. If the Master Controller or one of the slaves reports a hard error, it will open the line contactor. Likewise the Master Controller will also open the line contactor if one of the slave controllers fails to respond to it. Whenever the Master Controller opens the line contactor, it sends a warning message to each of the slaves that are sharing it to go into a 'safe' mode.

If parameters are set up incorrectly, the Master Controller will issue an error.

There are two programmable options – 0 and 1.

If set to 0 (No Sharing), then each controller must have a separate line contactor.

If set to 1 (Sharing), then the controllers with a CAN node number in sequence, starting from 1 on the CANbus network will be able to use the line contactor from the Master Controller. If this value is selected, then the parameter, 3.19 Last Sharing Node, must also be set on the Master Controller. Setting this parameter on a slave has no effect.

### I.19 Last Sharing Node – (LstNode)

Only the Master Controller uses this setting. If there are multiple controllers sharing a line contactor, connected via the CANbus, then this should be set to the highest node number of the sharing controllers.

For example, if there are four controllers connected and they have node numbers of 0, 1, 2 and 3, then this parameter should be set to 3.



## CHAPTER 5 – MOTOR SET-UP



## I Motor Set-up



Alteration of these parameters is only permitted when the vehicle is not pulsing.

Ref.	Parameter	Programmer Text
4.1	Motor Temperature Cutback	TempStrt
4.2	Motor to Vehicle Speed Ratio	SpdRatio
4.3	Number of Teeth	SpdTeeth
4.4	Number of Motor Poles	SpdPoles
4.5	Motor Speed Minimum	SPDmin
4.6	Motor Speed Boost	SPDboost
4.7	Motor Speed Base (Rated)	SPDbase
4.8	Motor Speed Maximum	SPDmax
4.9	Minimum Voltage	Vmin
4.10	Drive Voltage Minimum	D Vmin
4.11	Drive Voltage Boost	D Vboost
4.12	Drive Voltage Base (Rated)	D Vbase
4.13	Drive Voltage Maximum	D Vmax
4.14	Drive Slip Minimum	D Smin
4.15	Drive Slip Boost	D Sboost
4.16	Drive Slip Base (Rated)	D Sbase
4.17	Drive Slip Maximum	D Smax
4.18	Direction Braking Voltage Minimum	BDVmin
4.19	Direction Braking Voltage Boost	BDVboost
4.20	Braking Voltage Base (Rated)	B Vbase
4.21	Braking Voltage Maximum	B Vmax
4.22	Direction Braking Slip Minimum	BDSmin
4.23	Direction Braking Slip Boost	BDSboost
4.24	Braking Slip Base (Rated)	B Sbase
4.25	Braking Slip Maximum	B Smax
4.26	Neutral Braking Voltage Minimum	BNVmin
4.27	Neutral Braking Voltage Boost	BNVboost
4.28	Neutral Braking Slip Minimum	BNSmin
4.29	Neutral Braking Slip Boost	BNSboost
4.30	Braking Motor Speed Base (Rated)	BSPDbase
4.31	Proportional Gain for Voltage Change	PgainV
4.32	Proportional Gain for Outer Speed Loop	PgainSpd
4.33	Proportional Gain for Inner Torque Loop	PgainTrq
4.34	Ramp delay for Inner Torque Loop	Ramp Trq
4.35	Proportional Gain for Voltage Change – Neutral Braking Only	PgainSpN
4.36	Current Threshold	CurrTH
4.37	Lower Maximum Current	ImaxLow
4.38	Threshold Timer	lthTime
4.39	Hill Hold Time	HHtime
4.40	Hill Hold Restrained Speed	HHspeed
4.41	Hill Hold Minimum Voltage	HHmin
4.42	Brake End Speed	BrkEndSpd

## I.1 Motor Temperature Cutback – (TempStrt)

This sets the point at which the controller will begin to reduce its current output, in order to protect the motor. The temperature is measured by the motor's thermal sensor, which provides feedback via pin 4 of Connector C. The output will reduce linearly to zero at a point set by the value of this parameter plus 10°C.

The adjustable range is 1°C to 151°C in 1°C steps.

If set to 151°C, then the function will be disabled and no reduction in current will occur.

## I.2 Motor to Vehicle Speed Ratio – (SpdRatio)

This sets the relationship between the rotational speed of the motor and the actual driving speed of the vehicle, i.e. the overall vehicle gear ratio. This information, in conjunction with parameter, 1.30 Max. Vehicle Speed, is used to set the speed display on the Sigmagauge.

The value of this parameter should be the result of dividing the motor's speed in units of rpm by the vehicle's speed in units of kph.

Example: if a vehicle speed of 15kph corresponds to a motor speed of 3000rpm, then the value of this parameter should be  $3000/15 = 200$ .

The adjustable range is 1.0 to 999.9 in 0.1 step increments.

## I.3 Number of Teeth – (SpdTeeth)

This sets the number of pulses, i.e. teeth on the encoder that correspond to one motor revolution.

The adjustable range is 1 to 255 in 1 step increments.



**After the value has been changed, the keyswitch must be cycled for the new value to be accepted.**

## I.4 Number of Motor Poles – (SpdPoles)

The value of this parameter should be set to correspond to the number of motor poles.

There are two programmable options – 4 or 6.



**After the value has been changed, the keyswitch must be cycled for the new value to be accepted.**



**:: Motor Driving Set-up Explained ::**

The graph below shows the twelve parameters that are involved in setting up the drive performance of the controller & motor combination. Each of these parameters is explained in the following section.

The voltage and slip curves define the maximum permissible value for each, at a given motor stator (controller output) frequency. The controller then, in response to Accelerator position and speed feedback from the Motor Encoder, adjusts the voltage and slip values between their minimum and maximum values. The minimum voltage is 25% of the maximum motor voltage, whereas the slip has a theoretical minimum of zero.

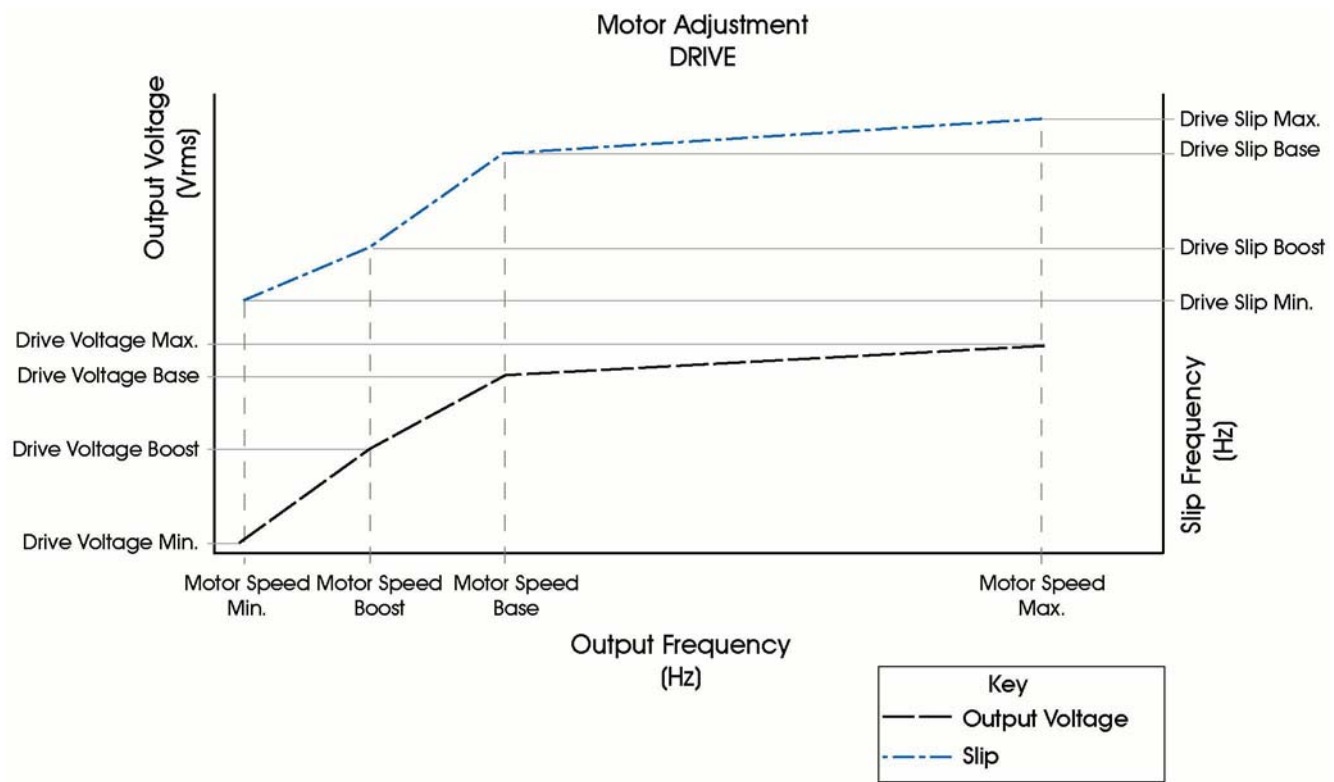

**I.5 Motor Speed Minimum – (SPDmin)**

This sets the minimum speed of the motor in both drive and braking scenarios.

A typical setting is between 1.0Hz and 2.0Hz.

The adjustable range is 0Hz to 63Hz in 0.0625Hz steps.

**I.6 Motor Speed Boost – (SPDboost)**

To compensate for stator voltage drops at low frequencies, the controller is able to supply a 'boost' voltage, between 4.5 Motor Speed Minimum and the speed set by this parameter.

The adjustable range is 0Hz to 255Hz in 1Hz steps.

### I.7 Motor Speed Base (Rated) – (SPDbase)

This should be set to the rated speed of the motor. This value is normally shown on the motor's nameplate or can be supplied by the motor manufacturer.

The adjustable range is 0Hz to 255Hz in 1Hz steps.

### I.8 Motor Speed Maximum – (SPDmax)

This sets the maximum speed of the motor required for the application.

The actual minimum value for this parameter should be at least 10% higher than the actual required motor speed. For example, if a maximum speed of 200Hz is required, then this parameter should be set to at least 220Hz.

The adjustable range is 0Hz to 255Hz in 1Hz steps.



**The four parameters detailed above are hierarchical – i.e. Motor Speed Base must never be set less than Motor Speed Boost or greater than Motor Speed Maximum.**

### I.9 Minimum Voltage – (Vmin)

This sets the minimum voltage to the motor in both drive and braking scenarios.

The adjustable range is 0V to 25.5Vrms in 0.1Vrms steps.

### I.10 Drive Voltage Minimum – (D Vmin)

This sets the controller output voltage that will be applied at the minimum speed setting.

The adjustable range is 0V to 25.5Vrms in 0.1Vrms steps.

### I.11 Drive Voltage Boost – (D Vboost)

This sets the controller output voltage that will be applied at the motor boost speed.

The adjustable range is 0.1V to 88.5Vrms in 0.1Vrms steps.

### I.12 Drive Voltage Base (Rated) – (D Vbase)

This should be set to the rated voltage of the motor. This value is normally stated on the motor's nameplate or can be supplied by the motor manufacturer.

The adjustable range is 0.1V to 88.5Vrms in 0.1Vrms steps.

### I.13 Drive Voltage Maximum – (D Vmax)

This sets the maximum controller output voltage that will be applied to the motor. The battery voltage of the vehicle usually limits this value.

The adjustable range is 0.1V to 88.5Vrms in 0.1Vrms steps.



**The four parameters detailed above are hierarchical – i.e. Drive Voltage Base must never be set less than Drive Voltage Boost or greater than Drive Voltage Maximum.**

### I.14 Drive Slip Minimum – (D Smin)

This sets the maximum value of slip that can be applied by the controller at the minimum speed setting.

The adjustable range is 0Hz to 15.93Hz in 0.0625Hz steps.

**I.15 Drive Slip Boost – (D Sboost)**

This sets the maximum value of slip that can be applied by the controller at the motor boost speed.  
 The adjustable range is 0Hz to 15.93Hz in 0.0625Hz steps.

**I.16 Drive Slip Base – (D Sbase)**

This should be set to the rated slip of the motor. This value is normally shown on the motor’s nameplate or can be supplied by the motor manufacturer.  
 The adjustable range is 0Hz to 15.93Hz in 0.0625Hz steps.

**I.17 Drive Slip Maximum – (D Smax)**

This sets the maximum slip that can be applied by the controller at the maximum speed setting.  
 The adjustable range is 0Hz to 15.93Hz in 0.0625Hz steps.

**:: Motor Braking Set-up Explained ::**

The graph below shows the additional thirteen parameters that are involved in setting up the braking performance of the controller & motor combination. Each of these parameters is explained in the following section.

The voltage and slip curves define the maximum permissible value for each, at a given motor stator (controller output) frequency. The controller then, in response to braking demand and speed feedback from the Motor Encoder, adjusts the voltage and slip values between their permissible minimum and maximum values.

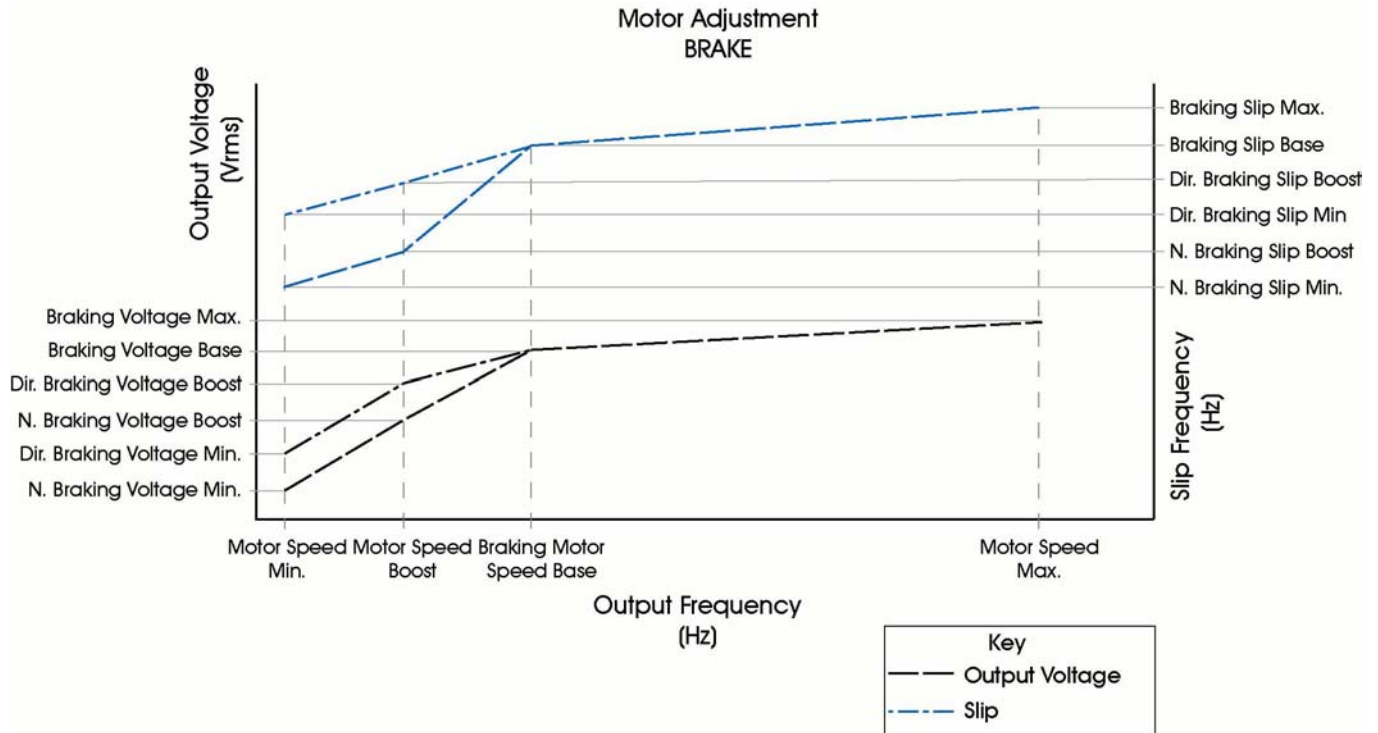

**I.18 Direction Braking Voltage Minimum – (BDVmin)**

This sets the controller output voltage applied at the minimum speed setting during Direction Braking.

The adjustable range is 0.1V to 88.5Vrms in 0.1Vrms steps.

**I.19 Direction Braking Voltage Boost – (BDVboost)**

This sets the controller output voltage applied at the boost speed setting during Direction Braking.

The adjustable range is 0.1V to 88.5Vrms in 0.1Vrms steps.

**I.20 Braking Voltage Base – (B Vbase)**

This sets the controller output voltage applied at the base speed setting during Direction and Neutral Braking.

The adjustable range is 0.1V to 88.5Vrms in 0.1Vrms steps.

**I.21 Braking Voltage Maximum – (B Vmax)**

This sets the controller output voltage applied at the maximum speed setting during Direction and Neutral Braking.

The adjustable range is 0.1V to 88.5Vrms in 0.1Vrms steps.



**'BDVboost', 'B Vbase' and 'B Vmax' are hierarchical – i.e. Braking Voltage Base must never be set less than Direction Braking Voltage Boost or greater than Braking Voltage Maximum. However, 'BDVmin' may be set higher than 'BDVboost' to help achieve a smoother transition from direction braking to drive.**

**I.22 Direction Braking Slip Minimum – (BDSmin)**

This sets the maximum value of slip applied by the controller at the minimum speed setting during Direction Braking.

The adjustable range is 0Hz to 15.93Hz in 0.0625Hz steps.

**I.23 Direction Braking Slip Boost – (BDSboost)**

This sets the maximum value of slip applied by the controller at the boost speed setting during Direction Braking.

The adjustable range is 0Hz to 15.93Hz in 0.0625Hz steps.

**I.24 Braking Slip Base (Rated) – (B Sbase)**

This sets the maximum value of slip applied by the controller at the base speed setting during Direction and Neutral Braking.

The adjustable range is 0Hz to 15.93Hz in 0.0625Hz steps.

**I.25 Braking Slip Maximum – (B Smax)**

This sets the maximum value of slip applied by the controller at the maximum speed setting during Direction and Neutral Braking.

The adjustable range is 0Hz to 15.93Hz in 0.0625Hz steps.



**'BDSboost', 'B Sbase' and 'B Smax' are hierarchical – i.e. Braking Slip Base must never be set less than Braking Slip Boost or greater than Braking Slip Maximum. However 'BDSmin' may be set higher than 'BDSboost' to help achieve a smoother transition from direction braking to drive.**

### I.26 Neutral Braking Voltage Minimum – (BNVmin)

This sets the controller output voltage applied at the minimum speed setting during Neutral Braking.

The adjustable range is 0V to 25.5Vrms in 0.1Vrms steps.

### I.27 Neutral Braking Voltage Boost – (BNVboost)

This sets the controller output voltage applied at the boost speed setting during Neutral Braking.

The adjustable range is 0V to 88.5Vrms in 0.1Vrms steps.



**Neutral Braking Voltage Boost must never be set less than Neutral Braking Voltage Minimum.**

### I.28 Neutral Braking Slip Minimum – (BNSmin)

This sets the maximum value of slip applied by the controller at the minimum speed setting during Neutral Braking.

The adjustable range is 0Hz to 15.93Hz in 0.0625Hz steps.

### I.29 Neutral Braking Slip Boost – (BNSboost)

This sets the maximum value of slip applied by the controller at the boost speed setting during Neutral Braking.

The adjustable range is 0Hz to 15.93Hz in 0.0625Hz steps.



**Neutral Braking Slip Boost must never be set less than Neutral Braking Slip Minimum.**

### I.30 Braking Motor Speed Base (Rated) – (BSPDbase)

This sets a separate base speed point during Direction and Neutral Braking for a smoother performance.

The adjustable range is 0Hz to 255Hz in 0.0625Hz steps.

### I.31 Proportional Gain for Voltage Change – (PgainV)

This sets the PI gain factor for Voltage. The vehicle drives more smoothly at a lower value or more responsively at a higher value.

The adjustable range is 1 to 16 in 1 step increments.

This parameter has no effect in Torque Control mode.

### I.32 Proportional Gain for Outer Speed Loop – (PgainSpd)

This sets the PI gain factor for the Outer Speed Loop. The vehicle approaches the speed limit more gradually with a lower value or more rapidly with a higher value.

The adjustable range is 1 to 16 in 1 step increments.

This parameter has no effect in Torque Control mode.

### I.33 Proportional Gain for Inner Torque Loop – (PgainTrq)

This sets the PI gain factor for the Inner Torque Loop. The vehicle drives more smoothly with a lower value or more rapidly with a higher value.

The adjustable range is 1 to 16 in 1 step increments.

This parameter has no effect in Torque Control mode.

### I.34 Ramp Delay for Inner Torque Loop – (Ramp Trq)

This sets the PI ramp delay for the Inner Torque Loop. The vehicle drives more smoothly with a higher value or more rapidly with a lower value.

The adjustable range is 0.1s to 10.0s in 0.1s steps.

This parameter has no effect in Torque Control mode.

### I.35 Proportional Gain for Outer Speed Loop in Neutral Braking – (PgainSpN)

As 4.32 but applies only in neutral braking. The vehicle approaches zero speed gradually at a lower value or more rapidly with a higher value.

The adjustable range is 1 to 16 in 1 step increments.

This parameter has no effect in Torque Control mode.

### :: Timed Current Limit Explained ::

The graph below shows the parameters that are involved in setting up the Timed Current Limit. This feature can be used to protect the vehicle's motor(s) from overheating.

If the current rises above a set threshold for a specified period of time, the controller can reduce the maximum current available to the motor(s). After the reduction has occurred, the maximum current output will remain at the lower level for a period of 3 times the 'threshold time'. If necessary, once this period has expired, the current can then be returned to its original level.

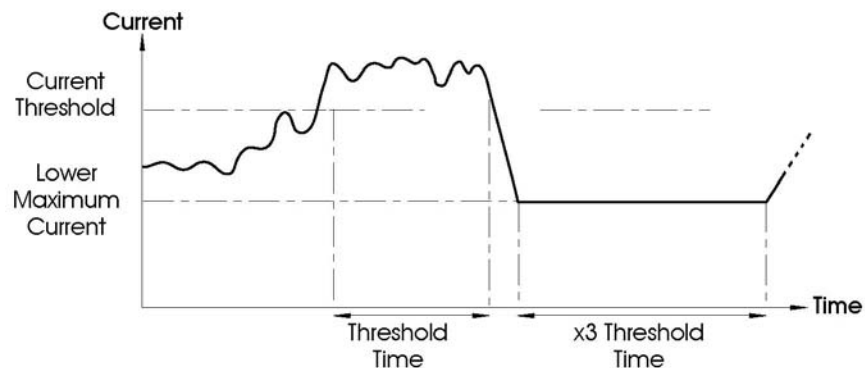

### I.36 Current Threshold – (CurrTh)

This sets the level of current, which if exceeded, will activate 4.37 Threshold Timer.

The adjustable range is 50Arms to the maximum rating of the controller in 10Arms steps.

### I.37 Lower Maximum Current – (ImaxLow)

This sets the value of the reduced current available to the motor(s), once the 4.36 Threshold Timer period has elapsed.

The adjustable range is 50Arms to the maximum rating of the controller in 10Arms steps.

### I.38 Threshold Timer – (IthTime)

This sets the period of time, which if exceeded, will initiate a reduction in the controller's maximum current output. A programmed value of zero disables the Timed Current Limit feature.

The adjustable range is 0s to 60s in 1s steps.

- Example:
- 4.36 Current Threshold is set to 420Arms
  - 4.37 Lower Maximum Current is set to 400Arms
  - 4.38 Threshold Timer is set to 10s

If the motor current is above 420Arms for 10 seconds, then the controller will reduce the maximum current available to 400Arms for a period of 30 seconds (3 x 10 secs).

There are maximum permissible values, which must not be exceeded, for each of these parameters. These values are shown in the table below.

	Maximum Drive Current	Current Threshold	Threshold Timer	Lower Maximum Current
ACT865L	460Arms	460Arms	60s	460Arms
ACT835M	250Arms	250Arms	60s	250Arms
ACT817S	120Arms	100Arms	20s	80Arms
ACT465L	460Arms	460Arms	60s	460Arms
ACT445M	320Arms	320Arms	60s	320Arms
ACT425S	180Arms	150Arms	20s	120Arms
ACT225S	180Arms	180Arms	60s	180Arms



**The values in the table above should never be exceeded.**

### I.39 Hill Hold Time (HHTime)

The function of this parameter is dependent on the setting of, 3.4 Anti Roll-off, in the Controller Set-up menu.

If set to '0' (Coast), then this parameter has no effect.

If set to '1' (Hill Hold & Restraint), then this determines the period of time that the vehicle will remain stationary on a gradient, following Neutral Braking. After this time, the controller will enter a Restraint mode at 4.40 Hill Hold Speed until the motor is no longer moving or the handbrake is applied.

If set to '2' (Restraint), then this determines the period of time that the controller will use DC current to restrain the vehicle, following Neutral Braking. After this time, the controller will enter a Restraint mode at 4.40 Hill Hold Speed until the motor is no longer moving or the handbrake is applied.

The adjustable range is 0s to 60s in 1s steps.

### I.40 Hill Hold Speed – (HHSpeed)

This sets the maximum speed of the vehicle during Restraint mode after 4.39 Hill Hold Time has passed.

The adjustable range is 0V to 25.5Vrms in 0.1Vrms steps.

### I.41 Hill Hold Voltage Minimum – (HHVmin)

This sets the minimum voltage that is used when the vehicle is in Hill Hold Mode. It overrides the setting of 4.9 Minimum Voltage.

The adjustable range is 0V to 25.5Vrms in 0.1Vrms steps.

**I.42 Brake End Speed – (BrkEndSpd)**

This sets the speed at which the controller goes into Hill Hold mode. Usually this parameter is set to 0Hz, however, the mass inertia of the vehicle may sometimes make it desirable to increase this value.

The adjustable range is 0Hz to 5Hz in 0.0625Hz steps.





## CHAPTER 6 – MOTOR SET-UP EXAMPLE



## I Example Set-up Procedure

If no detailed information is available, the motor label can be used to generate the set-up values. Below is an example of a typical motor label from a Chinese motor manufacturer.

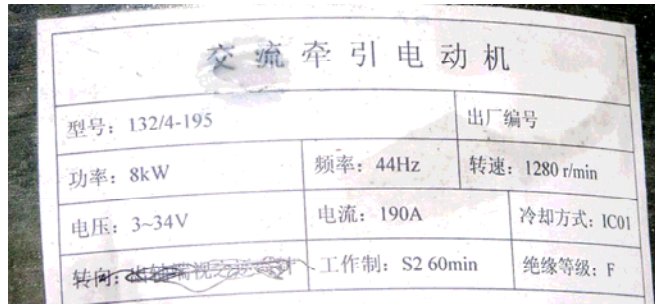

The following information is shown.

Motor Type		
Type: 132/4-195		
Power: 8kW	Frequency: 44Hz	Speed: 1280RPM
Voltage: 34V	Current: 190A	
	Rating: S2 60min	Insulation: F

This motor has a nominal rating of 8kW for 60 minutes.

8 kW is delivered at 44Hz, (rotor speed 1280rpm). The required voltage is 34Vrms and the current is shown as 190A.

To begin with, the number of pulses per revolution of the encoder and the number of poles in the motor must be programmed into the controller. The keyswitch must then be cycled.



**This information is vital: if the encoder pulses or the number of poles is wrong, you can get high motor currents or possibly a runaway motor.**

Let us assume that in this case, the parameter 4.3 Number of Teeth is set to 64 and the parameter 4.4 Number of Motor Poles is set to 4.

### II Drive speed set-up

The next step is to define the 4 speed points that form the motor graph for voltage and slip. As described in the Motor Set-up chapter, each speed point has got a separate setting for the maximum voltage and maximum slip.

The 4 speed points should be programmed as follows.

- Motor Speed Minimum, set to 0Hz.
- Motor Speed Boost, set to 70% of the base speed shown on the motor label, in this example 30Hz.
- Motor Speed Base, set to the base speed shown on the motor label, in this example 44Hz.
- Motor Speed Maximum, set to 1.5 times Motor Speed Base value or 10% higher than the maximum motor rpm required, whichever is greater, e.g. 125Hz.



**Ensure the values of I.4 Maximum Forward Speed and I.5 Maximum Reverse Speed are lower than the Motor Speed Maximum setting. If the actual motor speed is higher than this value, the Sigmadrive is out of control and will trip with an 'F30' error.**

## I.2 Drive voltage set-up

The drive voltage set-up is linear from the Motor Speed Minimum value to the Motor Speed Boost value.

The parameters, 4.11 Drive Voltage Boost, 4.12 Drive Voltage Base and 4.13 Drive Voltage Maximum should be set to the rated voltage shown on the label i.e. 34Vrms.

If the motor is rated at 34Vrms, the battery supply should be at least 48V ( $34\text{Vrms} \times \sqrt{2} = 48\text{V}$ ). However, in practice, if the battery is a little low and losses in the battery cable, motor cables and controller are taken into account, the actual voltage available could be lower, perhaps around 30Vrms. Above the value of 4.6 Motor Speed Boost, the voltage can no longer be increased, as there is no higher 'rms' voltage available from the battery supply. Therefore, the voltage levels at boost speed, base speed and maximum speed are normally set the same.

The parameter 4.10 Drive Voltage Minimum should be set to about 10% of the rated motor voltage.

The final value of the parameter 4.9 Minimum Voltage will depend on the application. If this is set too high then there will be high motor currents in neutral, which will heat up both the motor and controller. Initially, the value for this parameter should be set to 0.5Vrms enabling a minimum starting torque at zero speed.

Therefore, in this example the drive voltages should be programmed as follows.

- Minimum Voltage: 0.5Vrms
- Drive Voltage Minimum: 3.4Vrms
- Drive Voltage Boost: 30Vrms
- Drive Voltage Base: 30Vrms
- Drive Voltage Maximum: 30Vrms

## I.3 Drive slip set-up

The drive slip can also be calculated from the motor label information. In this example, the rotor speed is 1280 rpm at nominal power. First convert the rotor speed from rpm to Hz using the following rules.

There are 3 types of motors; 2 pole, 4 pole and 6 pole.

For 2 pole motors the rotor speed must be divided by 60.

For 4 pole motors the rotor speed must be divided by 30.

For 6 pole motors the rotor speed must be divided by 20.

Most motors, like the one in this example, are 4 pole. This gives a value of 42.66 Hz ( $1280 \text{ rpm} / 30$ ). Using this value the slip setting from minimum speed to base speed can be calculated as 1.33Hz ( $44\text{Hz} - 42.66\text{Hz}$ ). With this slip at base speed and 190A motor current we have an 8kW output. For acceleration and to climb a ramp we need more power than the 8kW. As the base speed is already programmed to the maximum motor voltage available, 30Vrms, the only possibility to achieve the required power is to increase the current, thereby increasing the slip. An ACT445M Sigmadrive can provide 320Arms motor current ( $450\text{A} / \sqrt{2}$ ).

The slip at Boost, Base and Maximum speed can now be calculated. In this example the Motor Speed Base point is at 44Hz. Using the following formula, the value for maximum slip can be calculated.

Maximum current (320Arms) / Nominal current (190Arms) \* Nominal slip (1.33Hz) = Maximum Slip (2.24Hz)

This slip setting, 2.24Hz is used for the parameters Drive Slip Boost, Drive Slip Base and Drive Slip Maximum. The parameter Drive Slip Minimum is set to 70% of the Drive Slip Base value. The relationship between current and slip is not linear but this set-up is usually a good starting point for a safe first test.

Therefore, in this example the settings would be as follows.

- Drive Slip Minimum: 1.57Hz
- Drive Slip Boost: 2.24Hz
- Drive Slip Base: 2.24Hz
- Drive Slip Maximum: 2.24Hz

By combining the values calculated so far, the following graph can be plotted.

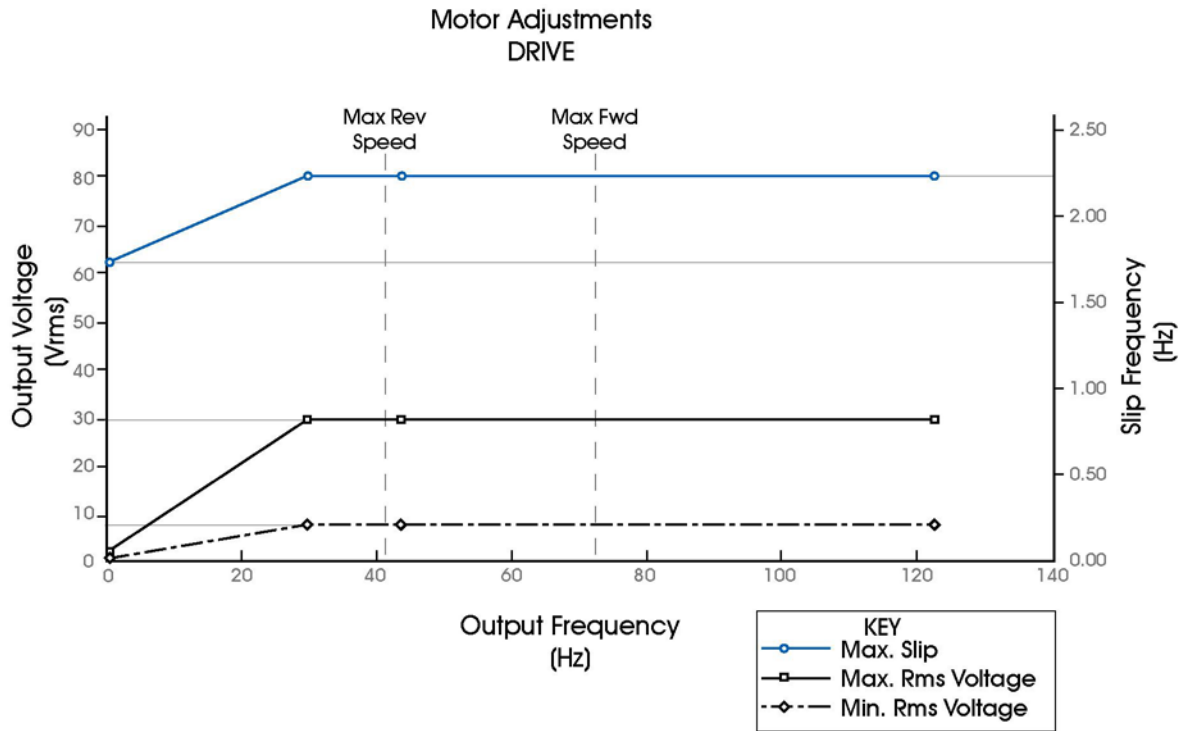

The 'basic' motor set-up for drive is now defined. Depending on the feedback from the speed encoder and the torque demand from the accelerator, the controller will vary the voltage between the minimum and maximum values shown on the graph. The slip will vary between 0Hz and the maximum setting for the given speed.

#### I.4 Motor set-up – Braking

The voltage and slip settings for braking are basically lower than those for driving. To ensure a smooth braking performance, a separate base speed point is added for braking. This allows the set up of a linear voltage line over the full speed range. Three different braking torque levels can be set in the Adjustments menu, 1.9 Direction Regen Braking, 1.10 Neutral Regen Braking and 1.11 Footbrake Regen Braking.



**Normally, the Direction Braking has the highest torque level, therefore, 1.9 Direction Regen Braking must be set to 100% in the Adjustments menu before starting to set up the motor braking table.**

#### I.5 Defining the Braking Motor Speed Base Point

The parameter 4.30 Braking Motor Speed Base is normally set to about 1 ½ times the value of the drive base speed. Therefore, in this example the setting would be as follows.

- Braking Motor Speed Base: 66Hz

## I.6 Brake Slip Set-up

The brake slip settings at minimum, boost and maximum should be set the same as for driving. Set the slip at the Brake Speed Base Point so that the brake slip graph is linear from the Boost to the Maximum point.

Therefore, in this example the settings would be as follows:

- Direction and Neutral Braking Slip Minimum: 1.57Hz
- Direction and Neutral Braking Slip Boost: 2.24Hz
- Braking Slip Base: 2.24Hz
- Braking Slip Maximum: 2.24Hz

## I.7 Brake Voltage Set-up

For braking there are separate voltage level settings for Neutral and Direction Braking at the Minimum and Boost Speed points. This is designed to soften the end of braking in neutral. The Footbrake uses the same motor set-up as Direction Braking. The Direction Braking voltage levels at Minimum and Boost level should be set at 50% of the drive voltage levels. For Neutral Braking the Minimum and Boost Voltage levels should also be set to 50% of the drive voltage levels. At Base and Maximum the voltage levels are set the same as for driving.

Therefore, in this example the settings would be as follows.

- Direction Braking Voltage Minimum: 1.7Vrms
- Direction Braking Voltage Boost: 15Vrms
- Neutral Braking Voltage Minimum: 1.7Vrms
- Neutral Braking Voltage Boost: 15Vrms
- Braking Voltage Base: 30Vrms
- Braking Voltage Maximum: 30Vrms

By combining the braking values calculated so far, the following graph can be plotted.

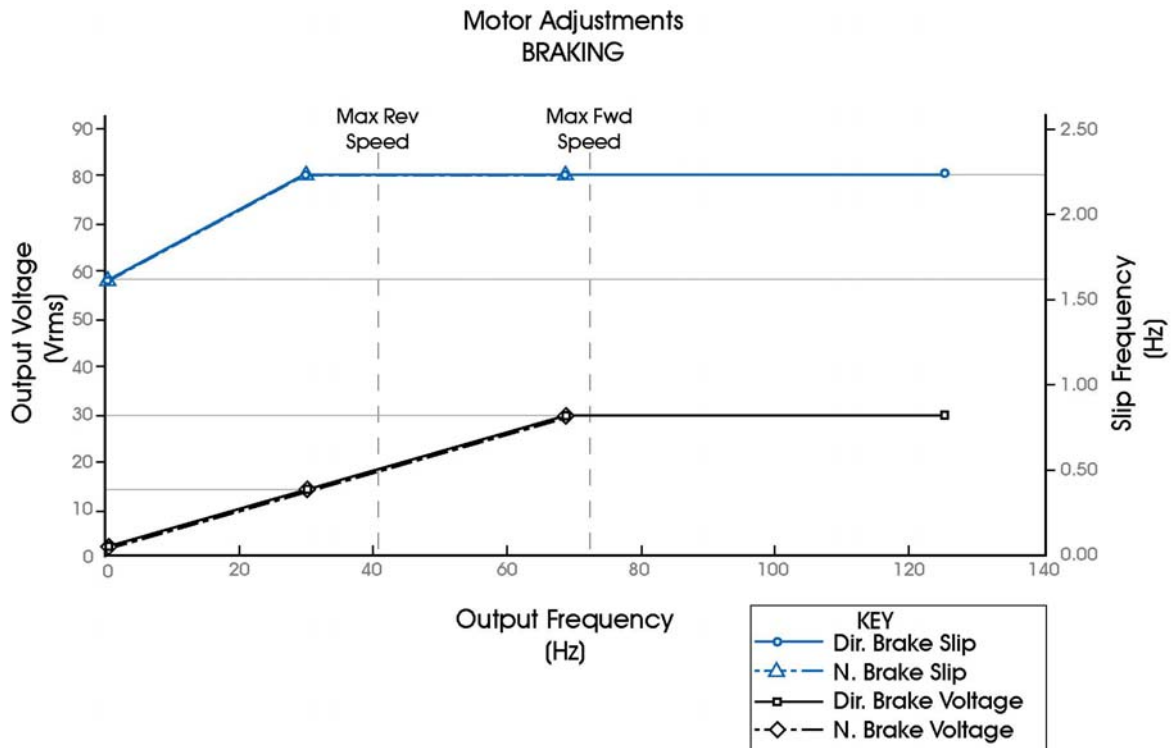

## I.8 Braking Percentage Levels

During Neutral Braking the controller will follow the motor set-up curve for voltage and slip. To increase or soften the Neutral Braking over the whole range, set the parameter 1.10 Neutral Regen Braking level to a higher or lower percentage level of the motor set-up. The same kind of adjustment is available for Footbrake and Direction Braking (1.11 & 1.9 respectively). The Footbrake can operate in two ways, either with a switch and a fixed braking torque or proportional torque with a potentiometer.

## I.9 Fine-tuning Drive

Now the basic set-up for nominal performance is finished, the vehicle can be tried carefully. First test the drive and brake performance at low speed, then go in a few steps towards full speed testing both driving and braking. To prevent speeds that are too high when testing, temporarily reduce the overall vehicle speed in both forward and reverse (1.4 & 1.5 respectively).

To get the right comfort feel, the voltage levels can be tweaked in small steps and tried out. Always check first at what frequency the performance must be tuned, the status menu can be used to determine this frequency. Likewise, the motor set-up graph can help to give a better feel for what kind of effect the motor setting change will have.

## I.10 Additional Torque

If the vehicle needs to be tuned for more power at pull-off, block the motor and check the motor current. Increase the value of the parameter 4.10 Drive Voltage Minimum in small steps until you reach the maximum current allowed for the motor or the controller. Now you can increase the value of 4.14 Drive Slip Minimum. If the truck starts to lurch, the slip is too high and can be reduced.

In this set-up the maximum unloaded speed of the vehicle on the flat is being optimized. The vehicle in this example has to drive unloaded at 14kph and loaded with 1.5 tons at 13kph. With a gear ratio of 17,733:1 and a wheel radius of 28cm, the rotor speed is 80Hz. We have to add the maximum slip to this speed (about 2 Hz slip) so we can set the maximum forward and reverse speed to 82Hz. Drive the truck at full speed and check the programmer status menu 2.14 to see if the rotor speed reaches 80Hz. 80Hz is in between the base speed and the maximum speed setting. By increasing or decreasing the slip value for these 2 points we can set more or less torque and current.

Now we can test the truck with load. Check if the speed reaches 13kph (74Hz). If not, change the slope from the slip curve so that the truck drives 13kph with the lowest possible current. Maybe increase or decrease the base speed setting to have an acceptable slope curve.

If this is O.K. the truck can be tested on a ramp. The specification for this truck is 8kph unloaded and 4 ~ 6kph with a load on a 15% ramp. This speed is between the Boost and Base Speed setting. By increasing the Boost Slip to 2.87Hz the truck was driving with 8kph and the lowest current up the ramp. The loaded speed up the ramp is between Minimum and the Boost Speed. If the torque is too low and increasing the slip is not enough, check the motor current. If the motor current is not at the maximum we can decrease the Boost Speed setting, which will increase the motor current.

Changing speed points in the motor set-up will also affect the braking curve. After changing speed points carefully, retest the braking performance.

## I.11 The Results After Fine-tuning

We need more slip around the boost speed to have enough torque to go up the ramp. We can lower it around the base speed and maximum speed because we don't need the maximum torque but we want maximum efficiency at full speed. The amended values and resulting plots on the graph are shown below.

- Motor Speed Minimum: 0Hz
- Motor Speed Boost: 30Hz
- Motor Speed Base: 70Hz
- Motor Speed Maximum: 125Hz
- Minimum Voltage: 0.6Vrms
- Drive Voltage Minimum: 3.8Vrms
- Drive Voltage Boost: 30.0Vrms

- Drive Voltage Base: 30.0Vrms
- Drive Voltage Maximum: 30.0Vrms
- Drive Slip Minimum: 1.50Hz
- Drive Slip Boost: 2.87Hz
- Drive Slip Base: 2.62Hz
- Drive Slip Maximum: 2.50Hz

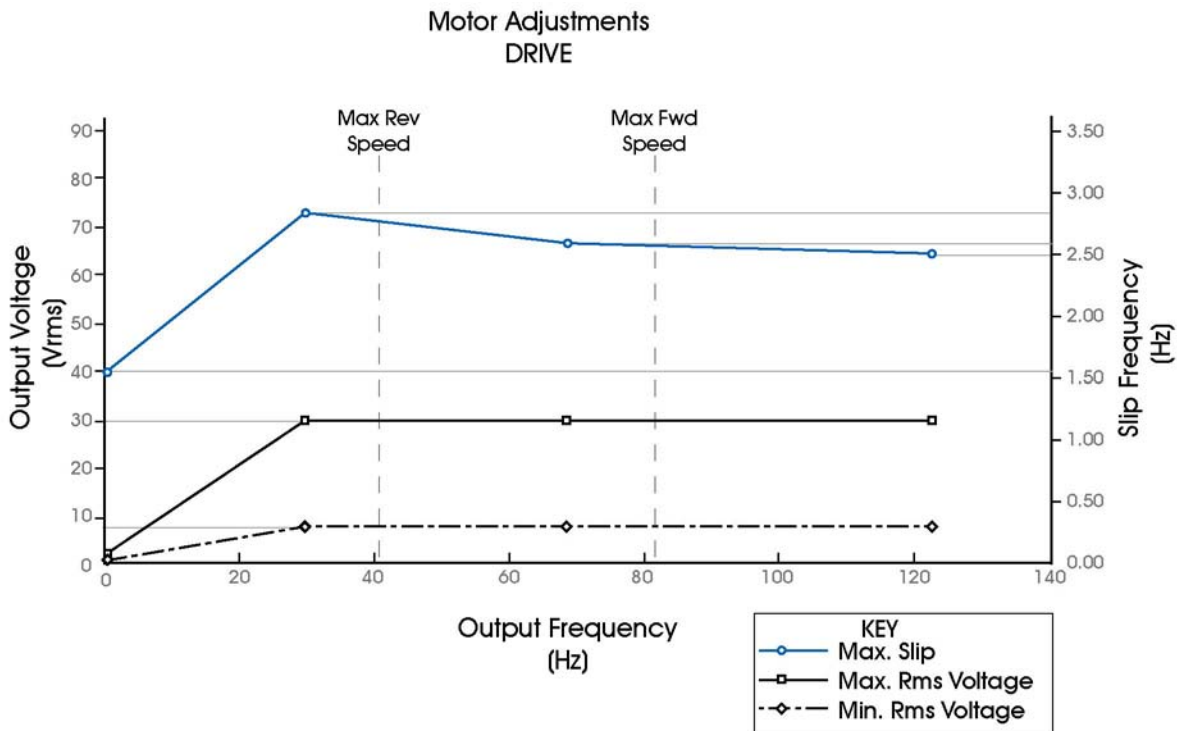

Always try to avoid reaching the I.17 Maximum Current Limit as the vehicle driver could sense this. The limit is for protection against over-current and should not be used as a means of control.

## I.12 Fine-Tuning Braking

Fine-tuning for braking is different between Torque control (3.2 set to 0) and Speed control (3.2 set to 1).

In Torque control, the curve is not linear, which can be noticed when braking. For example, if the torque is higher at Boost Speed than at Minimum and Base Speed the braking is not constant if you brake from Base Speed to zero. It is possible to increase the Minimum Voltage and Minimum Slip values as well as the Base Slip value to have a higher braking torque. If the braking torque feels constant from Maximum speed to zero speed, the set-up is O.K. After this, the braking torque can be limited by changing the brake settings 1.9, 1.10 and 1.11 in the Adjustments menu.

In Speed Control, braking is different. Braking is time related and not torque related. It is not easy to fine-tune the braking settings in Speed control. To get a good feel, you have to set braking up in Torque Control mode first and then revert to Speed Control mode.



When changing from Torque to Speed Mode, take care, as the delay settings I.2, I.12, I.13, & I.14 need to be set shorter with Torque Control, e.g., 0.3s and longer for Speed Control, e.g. 2.0s.



After fine-tuning, the following graph can be plotted.

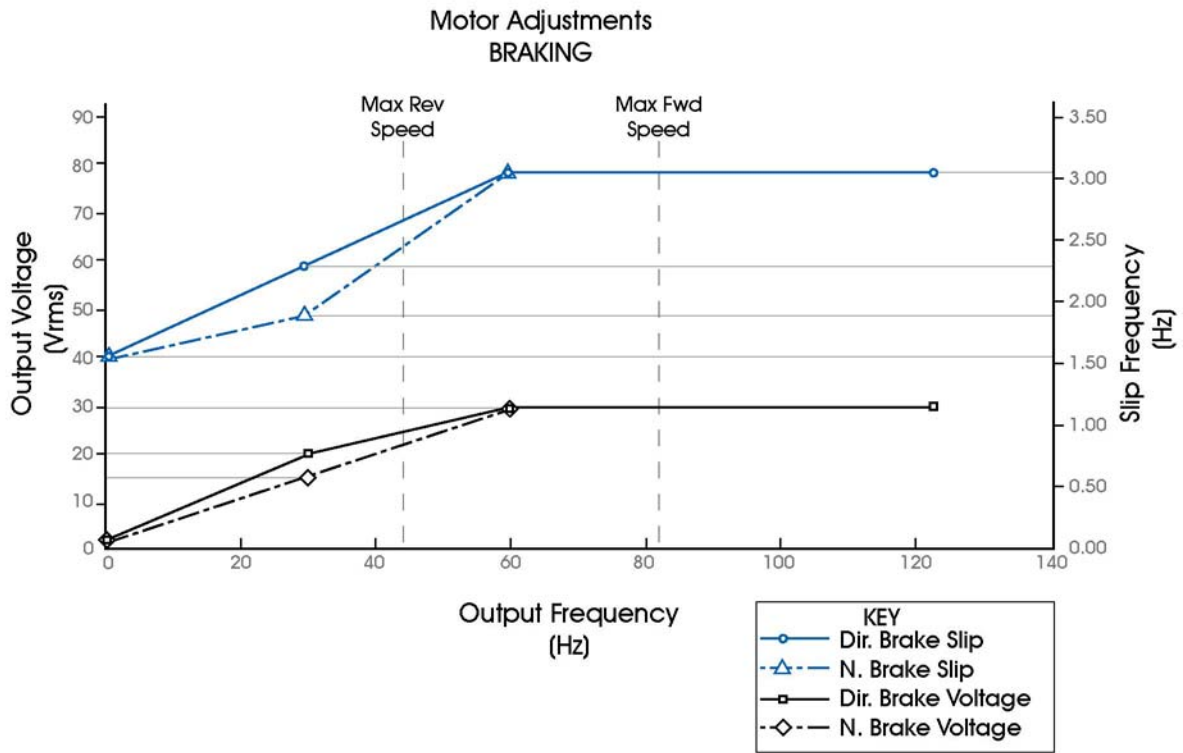

If you are in any doubt, please contact PGDT for further advice.





## CHAPTER 7 – HAND-HELD PROGRAMMER



## I Introduction

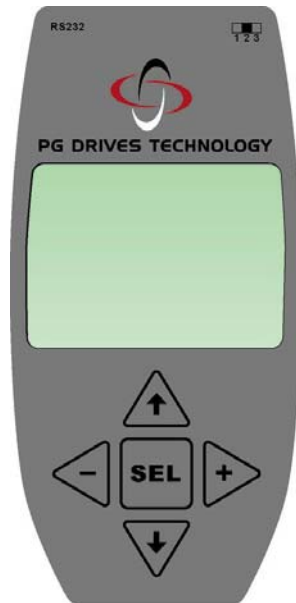

The Sigmadrive Hand-held Programmer is a powerful tool that can be used to configure all Sigmadrive controllers as well as the Sigmagauge display. In addition to multiple programming menus, there are status and test functions with powerful, real-time system information, making set-up or diagnosis particularly intuitive. The Programmer also has an interface for updating the controller's flash memory, as well as updating the Programmer's own software.

### 1.1 Interface Switch

On the top-right-hand side of the Programmer, there is a 3-way switch that is used to select the operating mode of the Programmer.



For normal Sigmadrive programming and diagnostics, this switch must be set to position 2.

Positions 1 and 3 are for Sigmadrive and Programmer software upgrades. Refer to the section Software Upgrades later in this manual for more details.

## 2 Connection

The Programmer is generally connected to a Sigmadrive, via the controller's 8-way Connector B.

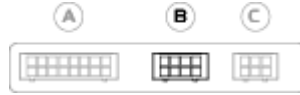

The exact method of connection of the Programmer will depend on how many Sigmadrive controllers are fitted to the vehicle being programmed.

If there is just one Sigmadrive, then connect the Programmer directly to Connector B on that controller.

If there is more than one Sigmadrive fitted, but these are not connected to each other via their CANbus, then program each controller separately.

If there is more than one Sigmadrive fitted and they are linked via their CANbus connections on Connector B, then it will be necessary to use an adaptor to provide a spare connection point for the programmer. In this instance, it will also be necessary to initially give each controller a unique CAN node number, see section CAN Node Set-up below.

The Programmer can be connected and disconnected at any time, regardless of whether the controller is on or off.

### 2.1 CAN Node Set-up

If the vehicle you are programming has multiple Sigmadrive controllers, connected via CANbus, then the Programmer will automatically scan the bus for all available CANbus nodes. Each CANbus node is identified by a number and the factory default for each controller is 0. Therefore, before undertaking any programming, each controller should be given a unique node number. To do this, disconnect the CANbus from each Sigmadrive, then connect the Programmer directly to each controller in turn and set the unique number. This is done via the programmable parameter, 3.17 CAN Node Number, in the Controller Set-up menu.

## 3 Using the Programmer

The Programmer has five buttons. The function of each is explained below.



This button is used to scroll up the on-screen menu.



This button is used to scroll down the on-screen menu.



This button is used to select a highlighted menu item, and to return to the main menu.



This button is used to decrement the value of a highlighted parameter.



This button is used to increment the value of a highlighted parameter.

## 4 Programmer Map

The Programmer has a menu structure that allows smooth and swift parameter adjustments, as well as system diagnostics and testing.

Upon initialization, the Programmer will display the 'Calibrator' screen, as shown below, which prompts you to select the controller type. (AC Traction is shown in this example). Once the controller type is selected, there are then programming, diagnostic and test options available.

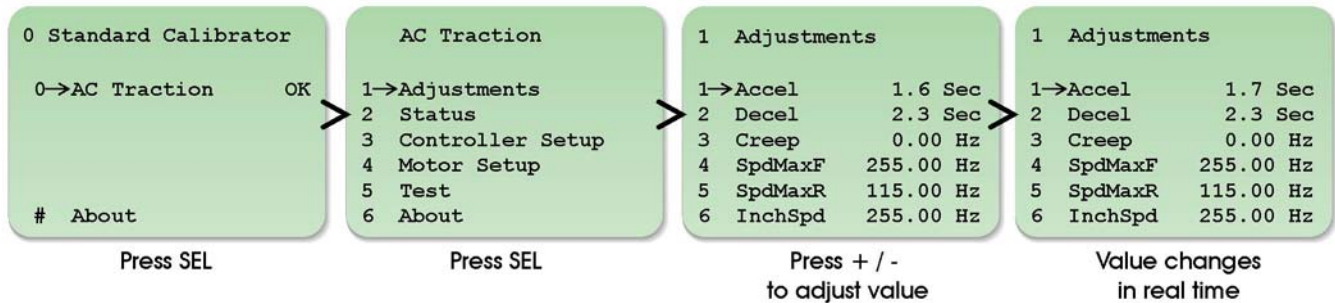

Some parameters e.g. 3.8 Truck Type Select, require that the power to the controller be cycled via the keyswitch before the new value will be accepted. These parameters are marked on the Programmer's screen with the word 'Key'.

### 4.1 Programming, Diagnostic and Test Options

#### 4.1.1 Adjustments

This menu includes parameters related to the application's performance, such as acceleration, speeds and BDI calibration. Refer to the Adjustments chapter for full details.

#### 4.1.2 Status

This menu allows you to select system and controller information for display, such as vehicle speed, battery voltage and controller temperature. Refer to the Diagnostics chapter for full details.

#### 4.1.3 Controller Set-up

This menu includes parameters related to the controller's operation, such as I/O configuration, throttle response and CAN node set-up. Refer to the Controller Set-up chapter for full details.

#### 4.1.4 Motor Set-up

This menu includes parameters specifically related to the type of motor being used. Refer to the Motor Set-up chapter for full details.

#### 4.1.5 Test

This menu allows you to select controller I/O status for display, such as the state of digital and analogue inputs, or contactor and LED outputs. Refer to the Diagnostics chapter for full details.

### 4.1.6 About

This menu option displays information about the system. The information is factory programmed into the controller by PGDT and is displayed as follows.

Cal Ref	Information Field	Example	
1	Customer Name	Cust	Standard
2	Application	App	Standard
3	Motor Type	Motor	AC
4	Controller Type	Type	PAC865TL01
5	Hardware Voltage and Current	HW	80V 460Arms
6	Software Version	SW	3.01.00 150107

## 5 Diagnostics

If the controller has detected an error, this will be displayed as a number (preceded by 'F'), on the right-hand side of the Controller Type screen, as shown below.

```

0 Standard Calibrator

0→AC Traction      F22

# About

```

In this instance, the error code is '22'. For details of this error, refer to the Diagnostics chapter.

## 6 Software Upgrades

The Programmer can be used to load revised software into the controller. Likewise, the Programmer's own software can be revised.

If either of these operations is required to be undertaken, PGDT will supply more detailed and specific instructions.





## CHAPTER 8 – CALIBRATION



## I Calibration

Ref.	Parameter	Programmer Text
7.1	Load Defaults	LoadDefs
7.2	Offset 1 M1	Ofset 1 +
7.3	Offset 2 M2	Ofset 2 +
7.4	Offset 3 M3	Ofset 3 +
7.5	Gain 1 M1	Gain 1
7.6	Gain 2 M2	Gain 2
7.7	Gain 3 M3	Gain 3

### I.1 Load Defaults – (LoadDefs)

There are two programmable options – 0 and 1.

If set to 0, the Sigmadrive will not restore defaults the next time the power is cycled.

If set to 1, the Sigmadrive will restore all adjustments and authorization codes to their default values the next time the power is cycled. It will also issue a warning error code '8' to indicate that all defaults have been restored.

The default value of this parameter is '0'.

The Offset and Gain parameters are excluded from the default settings.



**This option is not available on 'Standard' Programmers.**



**Care should be taken when utilizing this option. The motor set-up parameters, for example, will contain default values, which might be out of range for the motor used. This could cause damage to the controller and/or motors. PGDT accepts no liability for losses of any kind arising from failure to comply with this condition.**

### I.2 – I.7 Offset and Gain Settings.



**These parameters are factory settings and should not be altered under any circumstances.**





## CHAPTER 9 – SIGMAGAUGE



## I Introduction

The Sigmagaugue LCD is a highly versatile backlit, dot-matrix display, which presents vehicle status and diagnostic information to the operator, using clear, easy-to-read icons.

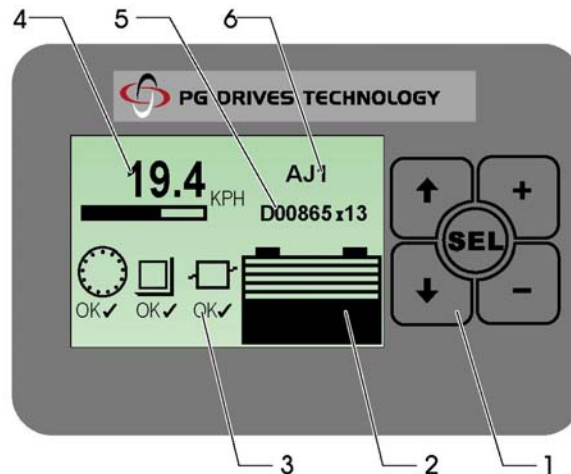

### 1.1 General Information

#### 1.1.1 Membrane Buttons

These are used for navigating and setting parameters in the Gauge Set-up menu.

#### 1.1.2 Battery Discharge Indicator

Indicates the battery discharge state as set by CAN Node 0 (Master).

#### 1.1.3 Fault Indication Field

Indicates the status of all Sigmadrive controllers in the system. A number is displayed within a 'traction', 'pump', 'steering wheel' or 'CAN I/O' icon to indicate which controller is experiencing a problem. When a fault is detected, the 'OK' symbol below the CAN node indicator, is replaced with a fault icon (see Diagnostics chapter). The value of 3.10 Display Error Indication, determines which failure types are displayed or ignored.

#### 1.1.4 General Indication Field

The information shown in this area of the Sigmagaugue is determined by the value set in 3.11 Display Status Field. Options are none, accelerator demand, motor speed, vehicle speed, steering angle and motor current.

#### 1.1.5 Hours Counter

Indicates either 'work' (drive) or 'key' hours & minutes, selectable in the Gauge Set-up menu. The hours counter value is stored in the display. The controllers have their own separate counter.

#### 1.1.6 Information Field

A 2x9 character field to show customized text, e.g. vehicle OEM and type. The membrane buttons can be used in the Gauge Set-up menu to edit the text displayed.

## 2 Connection

The Sigmagauge is connected to the Sigmadrive, via the controller’s 8-way Connector B.

The PGDT part number for the ‘Sigmagauge’ mating connector is D51069.

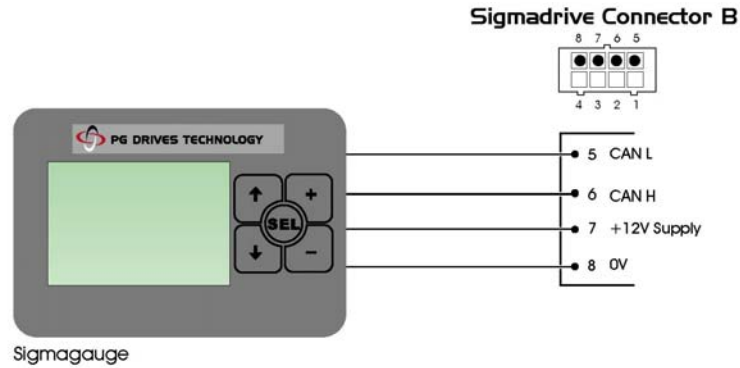

## 3 Mounting

Mounting the Sigmagauge module requires a rectangle to be cut into the vehicle dashboard, allowing the module to rest on the surface of the dash.

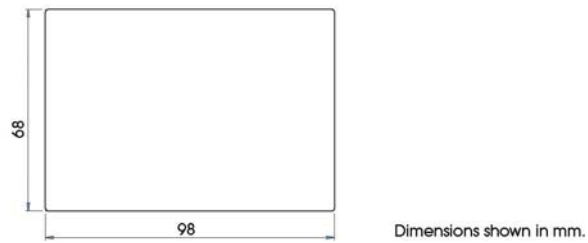

Before cutting the hole, ensure that enough room is available within the dash for the area of the module and the Securing Bracket. Access to the back of the dash will be required to secure the Sigmagauge.

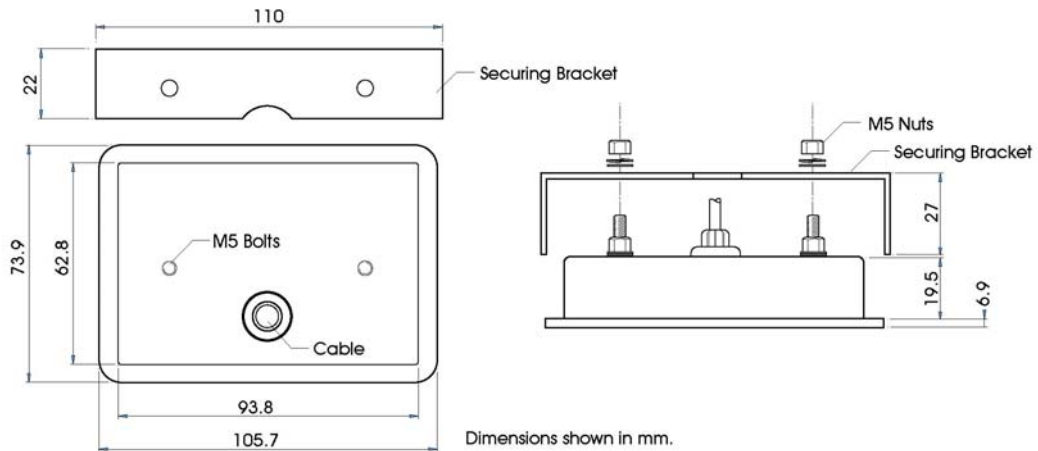



- Once the cut-out is ready, ensure that all debris is removed and the surface is clean.
- Place the Sigmagauge in the hole.
- Raise the Securing Bracket from beneath the dash surface and locate onto the mounting bolts.
- Once located, fasten using the M5 nuts supplied.



To maintain a good weather seal, it is suggested that a waterproof adhesive is used to seal and secure the Sigmagauge to the dash.

## 4 Configuring the Sigmagauge

To access the Gauge Set-up menu, press and hold the 'SEL' button for 3 seconds. Features such as the Service Interval Timer, Hours Counter and Text Field can be adjusted and optionally protected with a pin code. Use the up and down arrow buttons to choose an option, 'SEL' to select an option and the '+' & '-' buttons to amend the current value.

The table below shows the structure of the Gauge Set-up menu. It describes the action and range of each available parameter.

Ref.	Parameter	Sub Menu Reference	Sub Menu Description	Range & Action
1	Service timer	1. Svc interval	Set the time interval for the next service	0 – 32767 Hrs. (Warning starts 40 hours before service required)
		2. Count hours	Set to count 'work' (drive) or 'key' hours	Work / Key Hrs.
		3. Reset timer	Resets the Service Timer (sub menu ref '4')	To confirm, press 'SEL'
		4. Svc time	Indication of the actual counter value	Indication only
2	Hours counter	1=Key, 2=Work	Select to indicate 'work' or 'key' hours	Select with up & down arrows and confirm with 'SEL'
3	Information field	1. Adjust field	Free 2x9 character field to show customized text	Use up and down arrows for position, '+' & '-' to change value and 'SEL' to return to menu
4	Pincodes	1. Service timer	Sets pin code for service timer access	
		2. Information field	Sets pin code for information field access	
		3. Reset all pincodes	Reset all pin codes	Contact PGDT
5	About	SW version and date	Indication of the software version and date	Indication only
6	Return	-	Select to return to main menu	Select with up & down arrows and confirm with 'SEL'





## CHAPTER 10 – TECHNICAL SPECIFICATIONS



## I Electrical

### I.1 Voltage Specifications

Model	Voltage	Nominal Battery Voltage	Absolute Operating Voltage Range
ACT2xxX	24V Units	24V	14.5 – 34.0V
ACT4xxX	48V Units	24-48V	14.5 – 61.0V
ACT8xxX	80V Units	72-80V	43.0 – 98.0V

### I.2 Current Specifications

Model	Voltage	Maximum Current (rms) / Time	Continuous Current (rms) – 1 Hour
ACT225S	24V	180A / 60s	80A
ACT425S	48V	180A / 20s	80A
ACT445M	48V	320A / 60s	180A
ACT465L	48V	460A / 60s	260A
ACT817S	80V	120A / 20s	70A
ACT835M	80V	250A / 60s	120A
ACT865L	80V	460A / 60s	240A

Switching Frequency: Controller frequency is 8KHz.

Motor frequency is 16KHz.

Electrical Isolation: Enclosure to any live part = 1KV. Controller internal insulation specified at > 10MΩ @500V DC.

## 2 Environmental

Ingress Protection (IP): The enclosure is protected to IP54 (varnished PCB).

Vibration: 6G, 40-200Hz for 1 hour, in x, y and z planes.

Operating Temperature: -30°C to +40°C ambient around controller.

Storage Temperature: -40°C to +70°C.

Humidity: 95% maximum, non-condensing.

### 3 Mechanical

Dimensions:	Refer to frame drawings in Installation chapter.
Enclosure:	Aluminium heatsink with ABS plastic cover.
Recommended fixing torques:	Large and Medium frame – 11Nm    Small frame – 9Nm.
Maximum screw thread penetration depth:	All frame sizes – 14mm.
Weight:	Small: 1.2Kg; Medium: 4.1Kg; Large: 6.1Kg.



**Always use a torque screwdriver when fixing the power terminals.**



**Exceeding the maximum specified torque can cause serious damage to the controller and warranty may be void.**



**Screws that are too long will damage the controller.**